

Programming Nanoscale Structure Using DNA-Based Information

Nadrian C. Seeman

**Department of Chemistry
New York University
New York, NY 10003, USA
ned.seeman@nyu.edu**

**Visions of the Theory of Computing
Berkeley, CA
May 30, 2013**



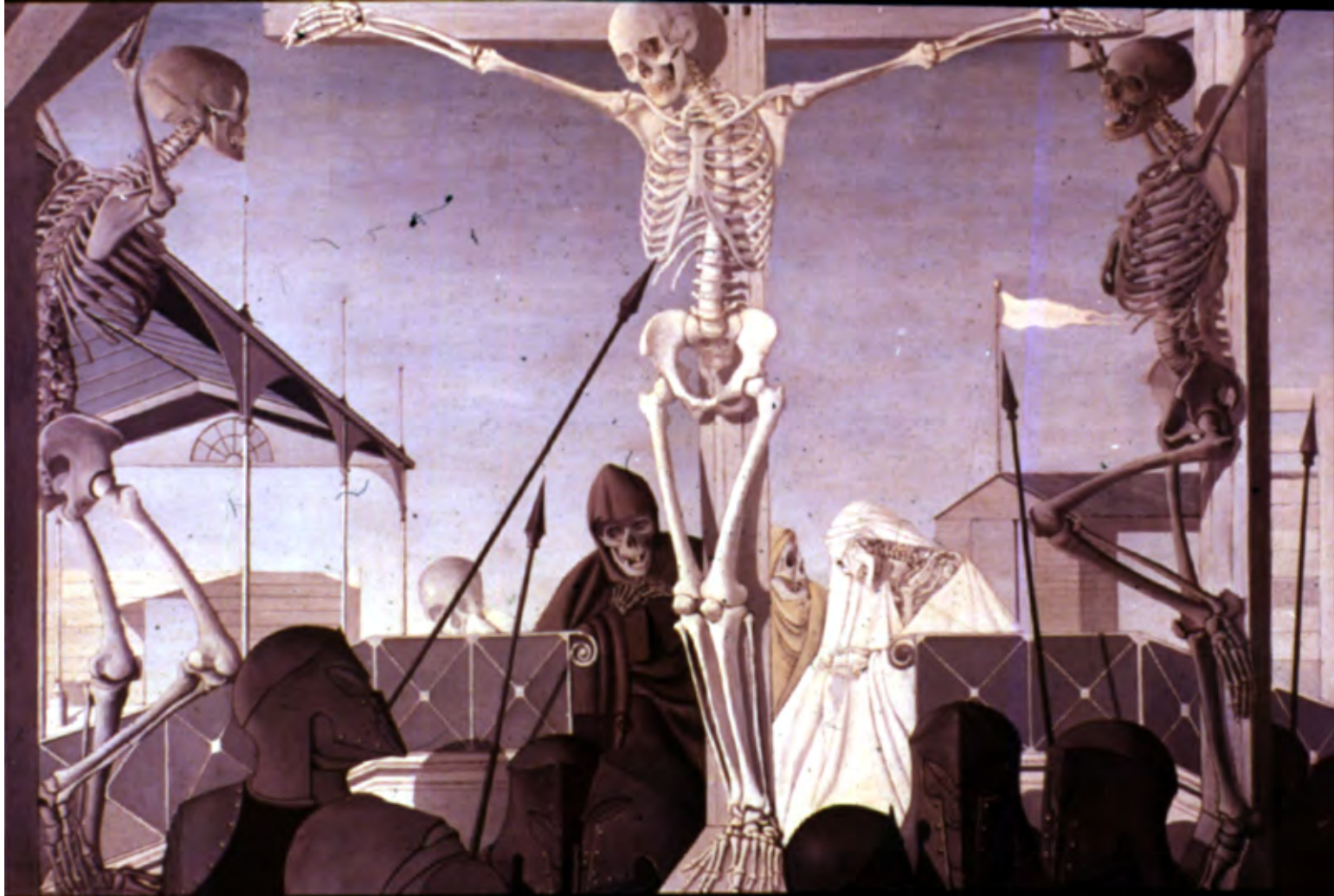



DNA Is a Nanoscale Object

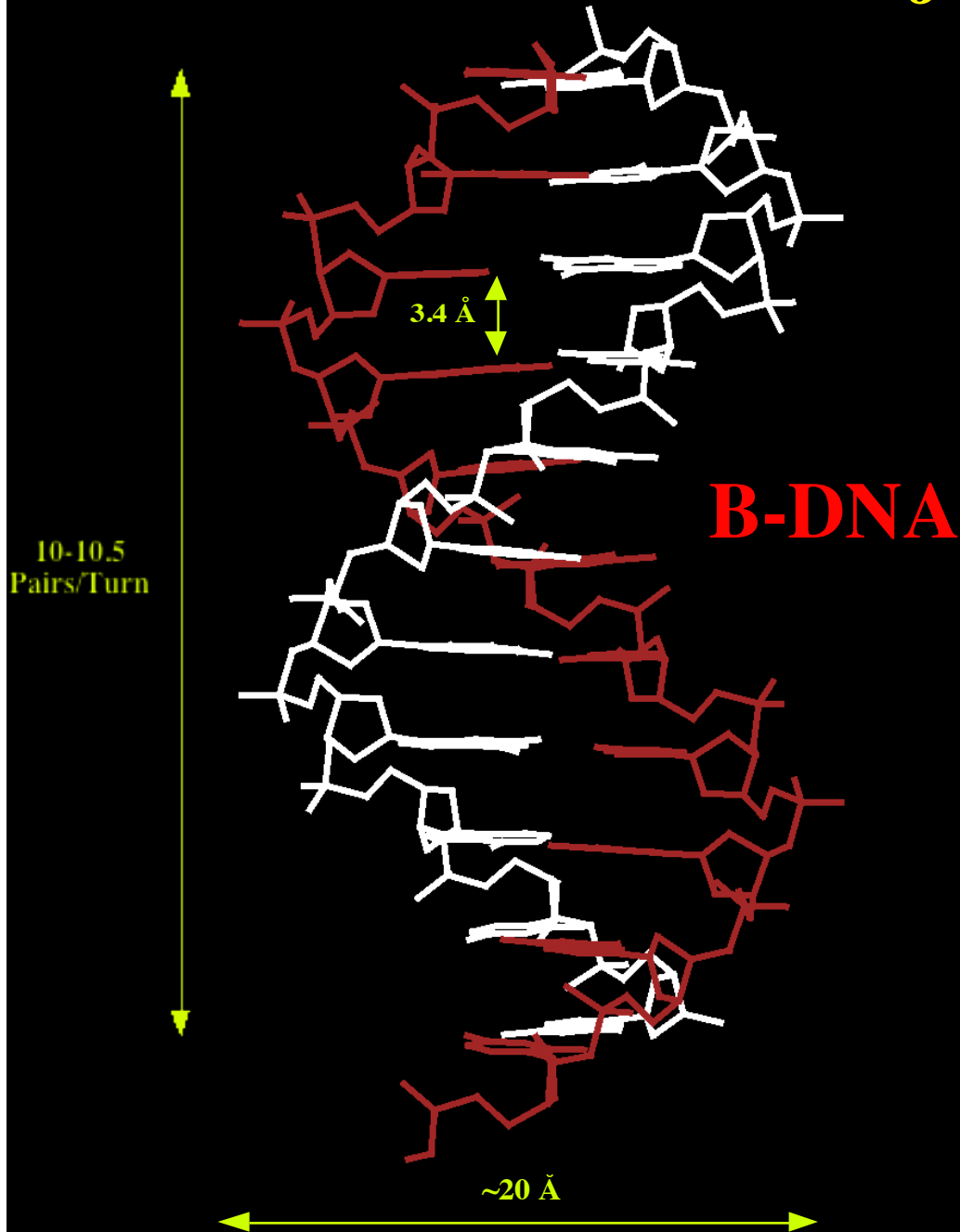

DNA BASE PAIRS

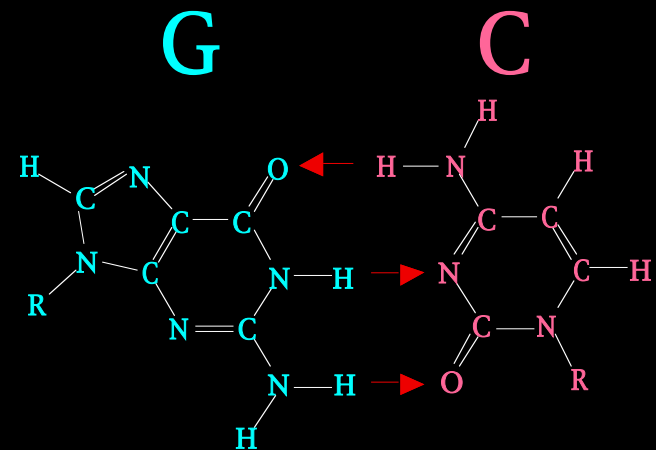
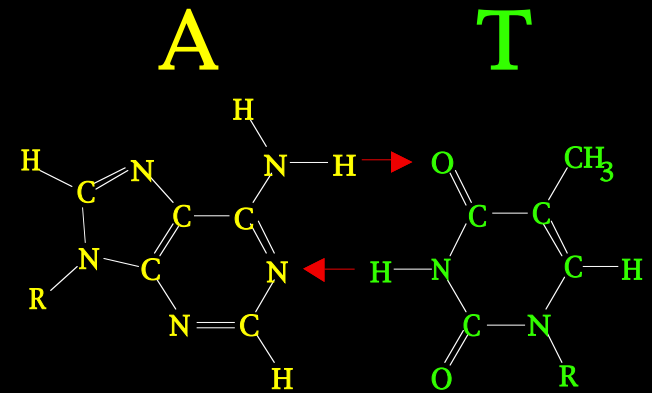

Reciprocal Exchange: A Theoretical **Biokleptic** Tool To Generate New DNA Motifs

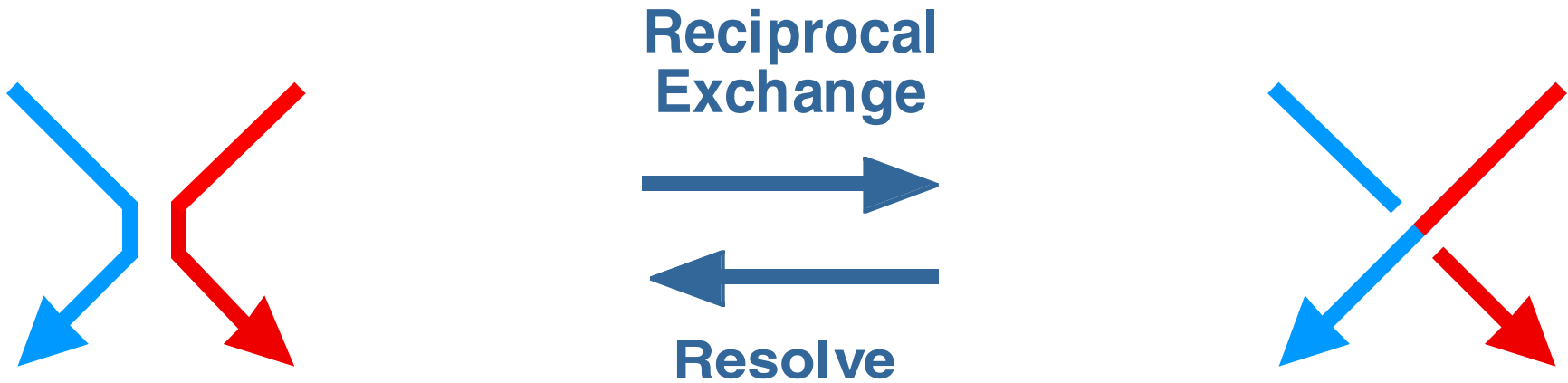

Reciprocal Exchange in a Double Helical Context

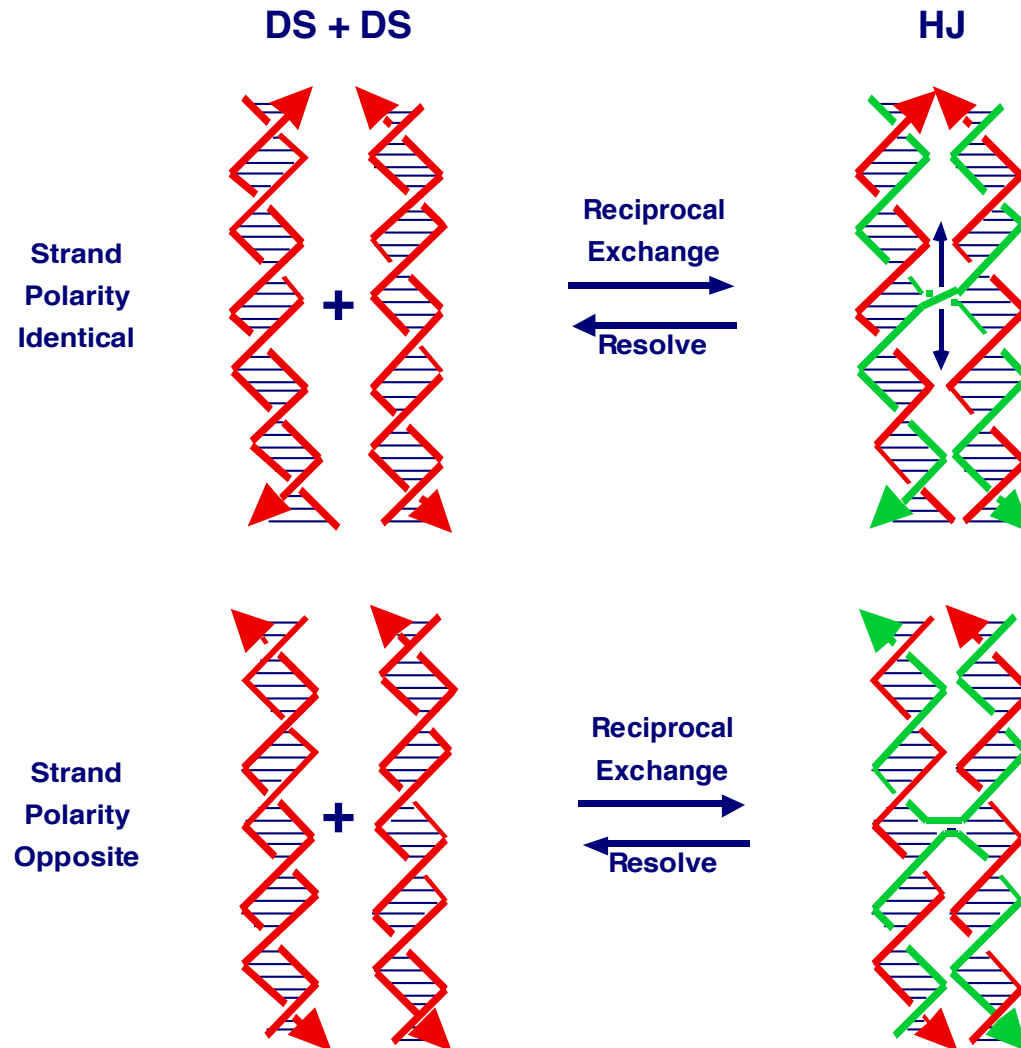

Design of Immobile Branched Junctions: Minimize Sequence Symmetry

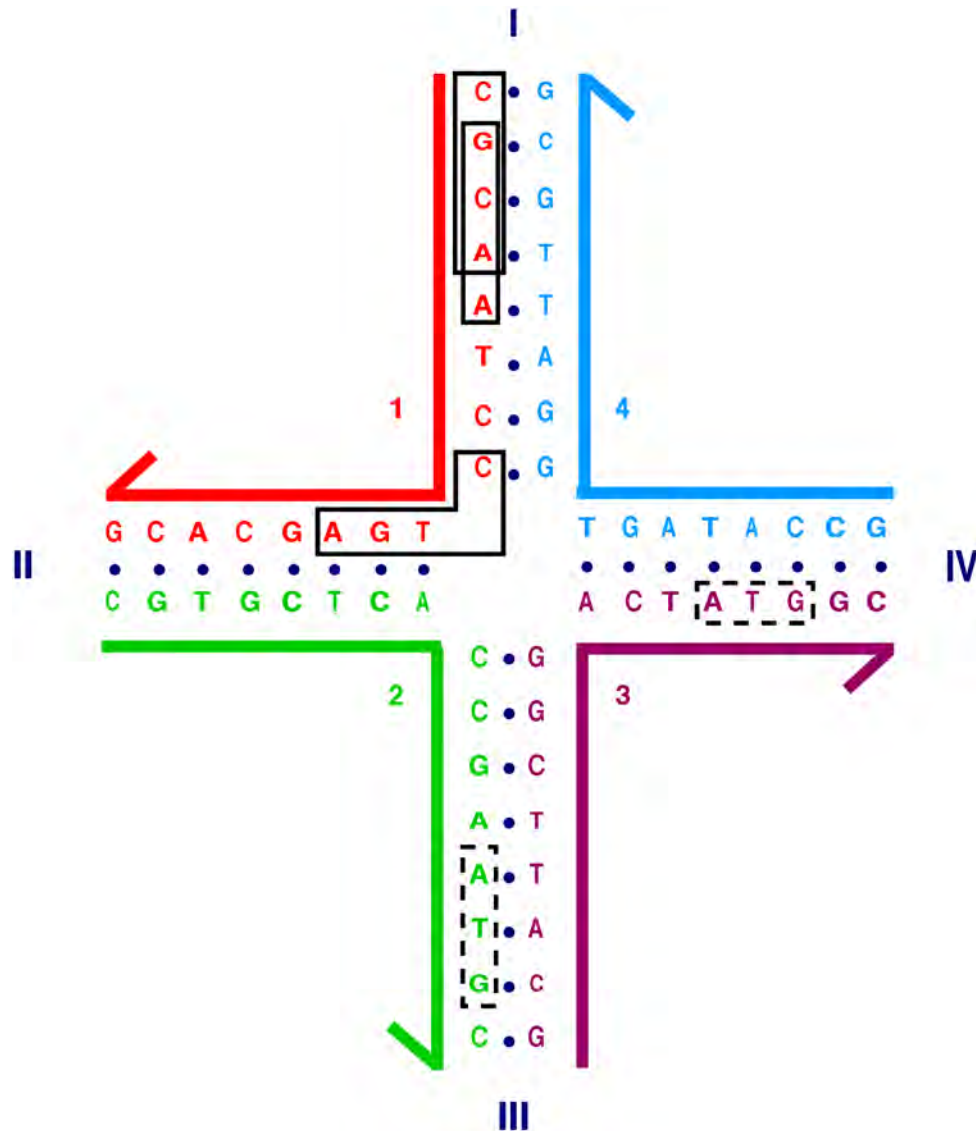

5-Arm, 6-Arm, 8-Arm and 12-Arm Junctions

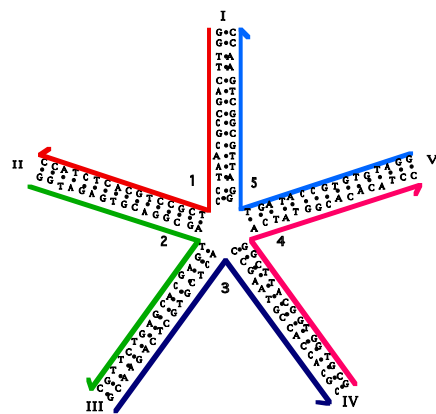

JYL5G

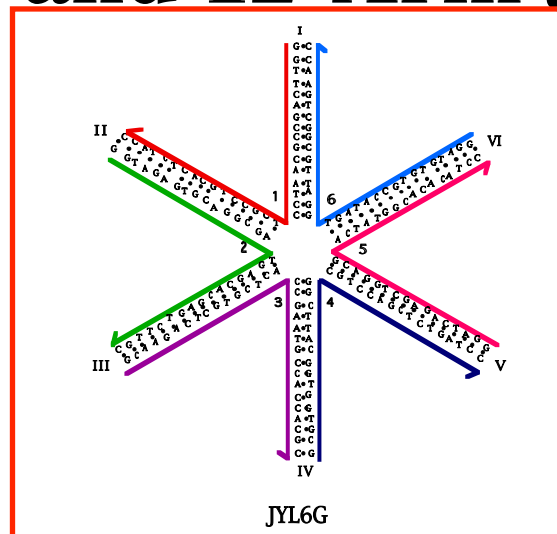

JYL6G

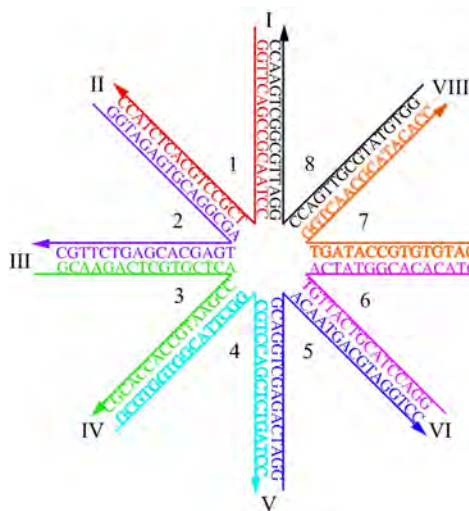

JXW8G

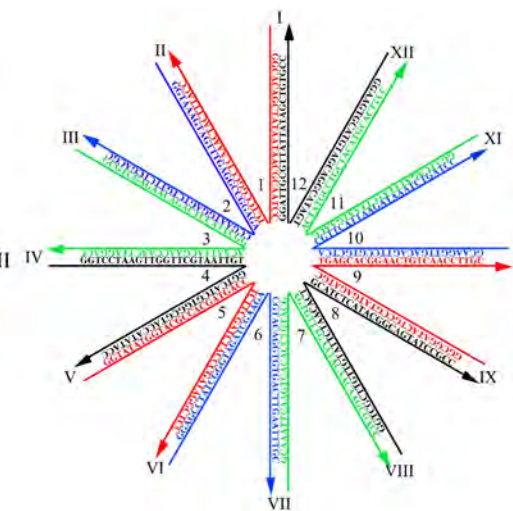

JXW12G

Wang, Y., Mueller, J.E., Kemper, B. & Seeman, N.C. (1991), *Biochemistry* **30**, 5667-5674.
 Wang, X. & Seeman, N.C. (2007), *J. Am. Chem. Soc.* **129**, 8169-8176.



Sticky-Ended Cohesion: Easily **Programmed** Affinity

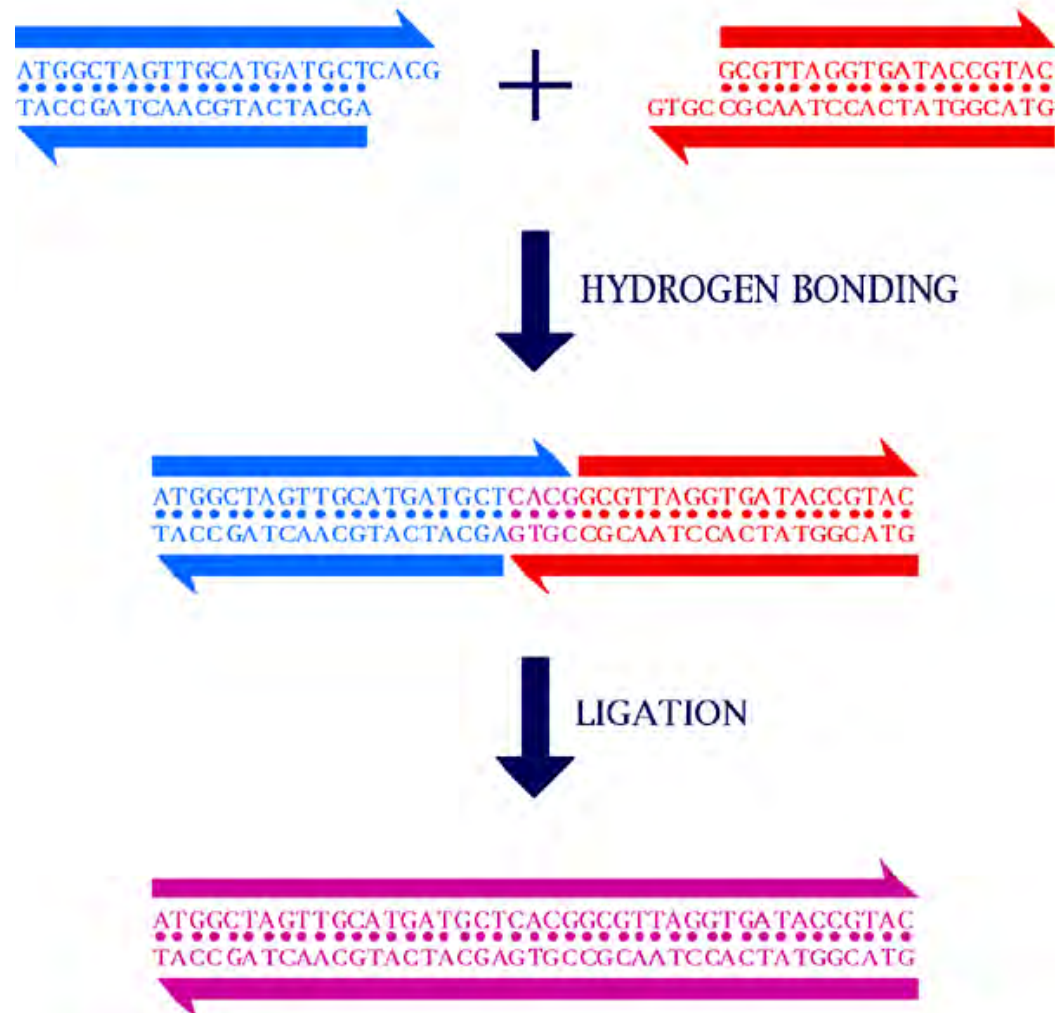

Sticky-Ended Cohesion: Structure

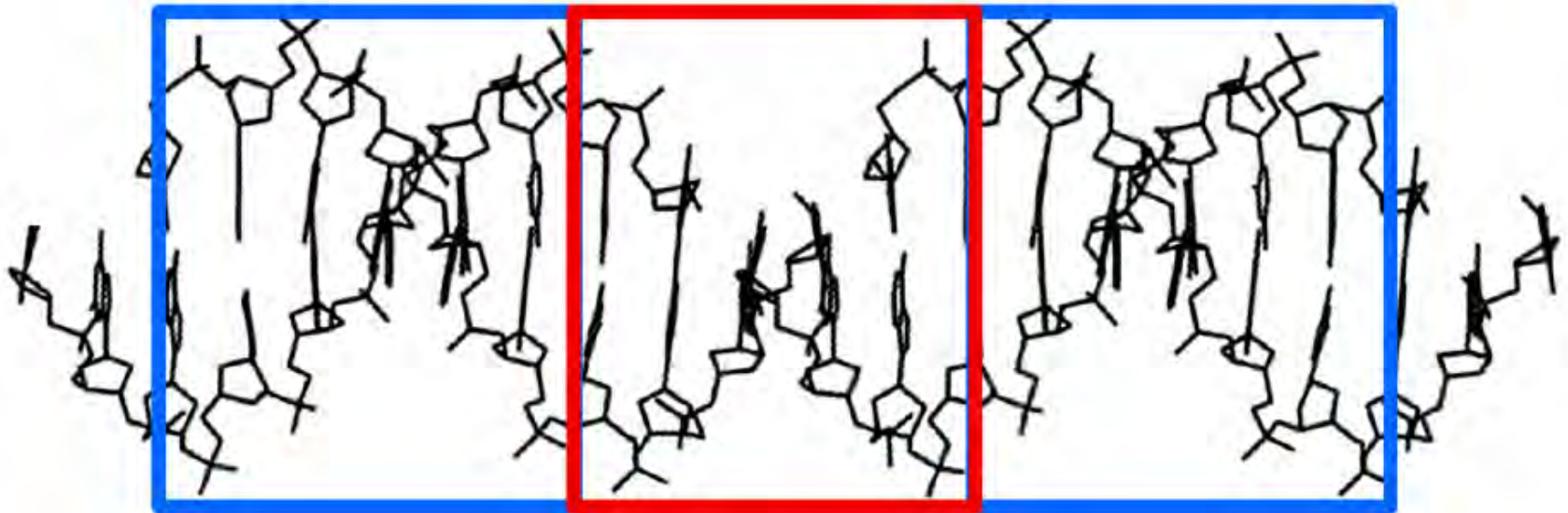

The Central Concept of Structural DNA Nanotechnology: Combine Branched DNA with Sticky Ends to Make Objects, Lattices and Devices

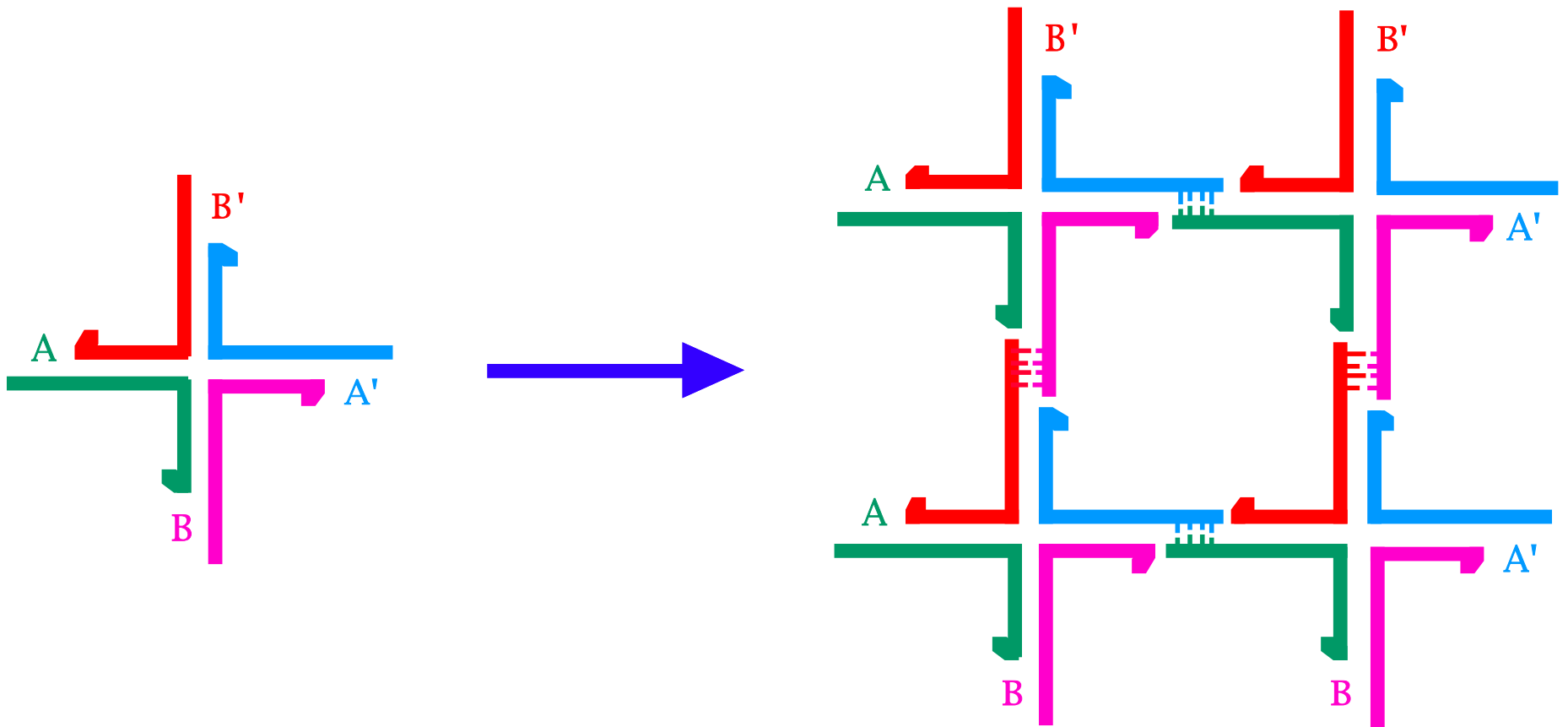

OBJECTIVES AND APPLICATIONS FOR OUR LABORATORY

ARCHITECTURAL CONTROL AND SCAFFOLDING

- [1] MACROMOLECULAR CRYSTALLIZATION (PERIODIC IN 2D AND 3D).**
- [2] NANOELECTRONICS ORGANIZATION (PERIODIC IN 2D AND 3D).**
- [3] DNA-BASED COMPUTATION (APERIODIC IN 2D OR 3D).**
- [4] CONTROL OF POLYMER AND MATERIALS COMPOSITION & TOPOLOGY.**

NANOMECHANICAL DEVICES

- [1] NANOROBOTICS.**
- [2] NANOFABRICATION.**

SELF-REPLICABLE SYSTEMS

CURRENT CRYSTALLIZATION PROTOCOL

GUESS CONDITIONS

DO CRYSTALLOGRAPHY

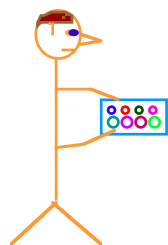

SET UP CRYSTALS

PRAY FOR CRYSTALS

CRYSTALS?

YES

NO

CHANGE DEITIES

GUESS NEW CONDITIONS

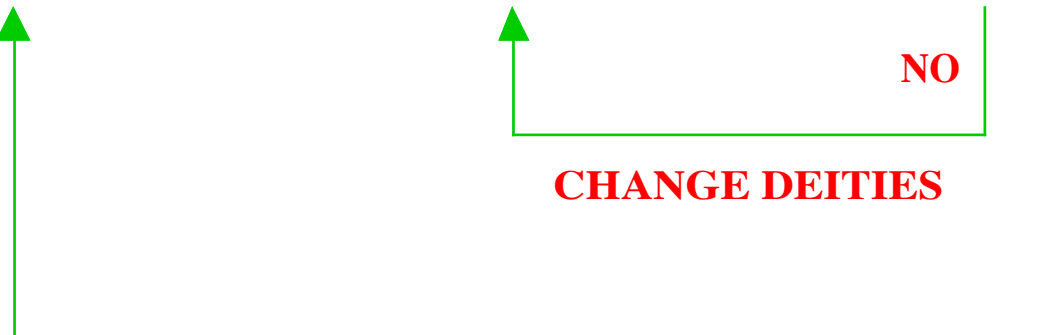

A New Suggestion for Producing Macromolecular Crystals

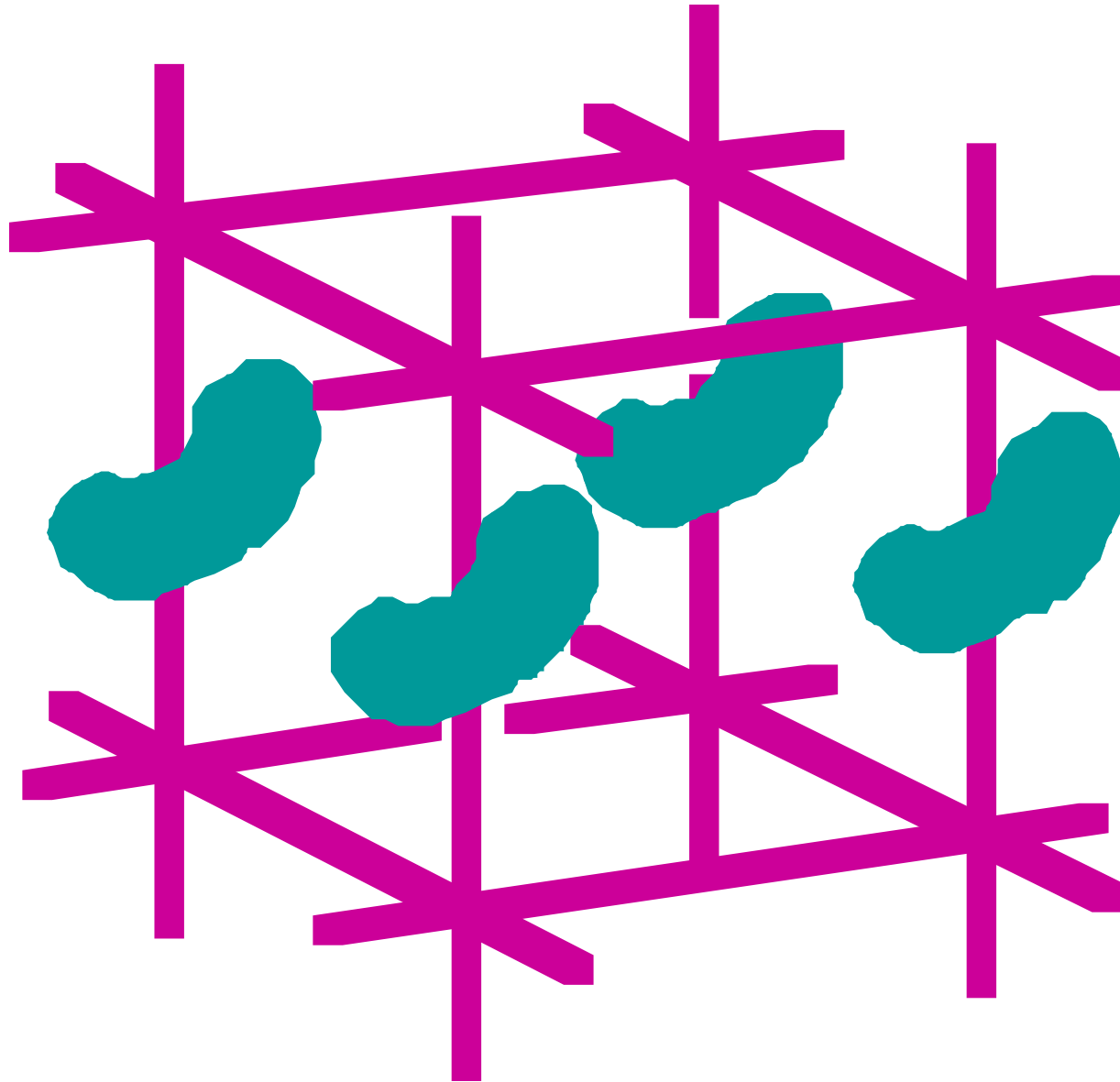

A Method for Organizing Nano-Electronic Components

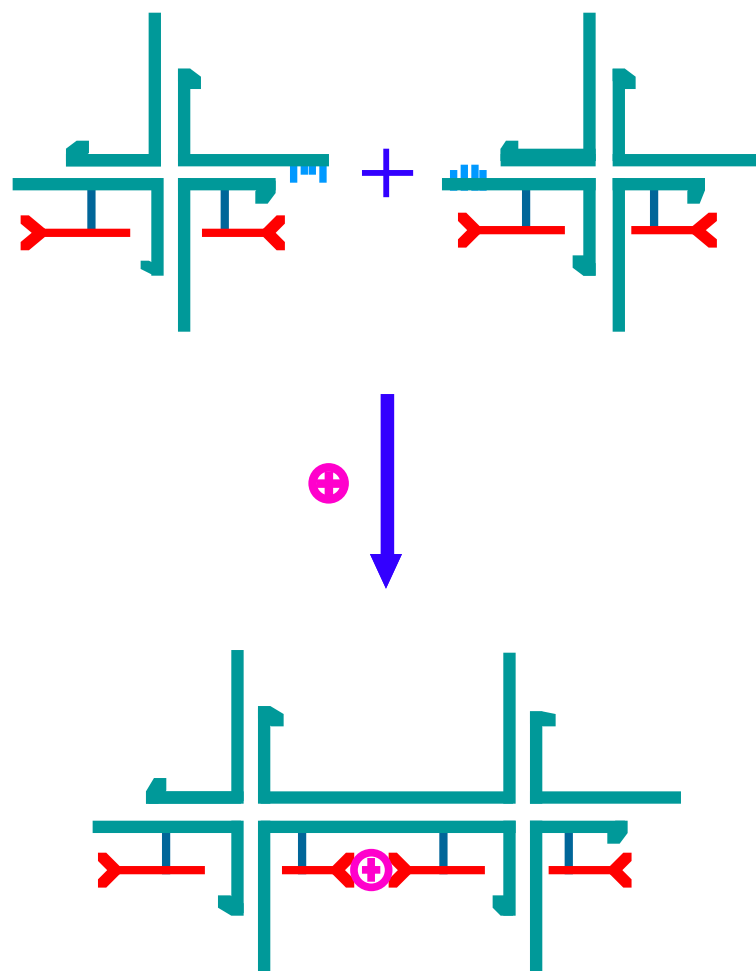

Why DNA?

Nucleic Acid Sequences Can Be Programmed and Synthesized, Leading to Information-Based Structural, Dynamic and Catalytic Chemistry

Predictable Intermolecular Interactions:

Both Affinity and Structure.

Can Design Shape by Selecting Sequence:

Robust Branched Motifs Programmable by Sequence.

Convenient Automated Chemistry:

Both Vanilla DNA and Useful Derivatives.

Convenient Modifying Enzymes:

Ligases, Exonucleases, Restriction Enzymes, Topoisomerases.

Locally A Stiff Polymer:

Persistence Length ~ 500 Å; Stiff Branched Motifs Have Been Developed.

Robust Molecule:

Can Heat Individual Strands without Doing Damage.

Amenable to Molecular Biology and Biotechnology Techniques:

Gels, Autoradiography, PCR.

Externally Readable Code when Paired:

Different Points in a Lattice Can be Addressed.

High Functional Group Density:

Every 3.4 Å Nucleotide Separation.

Prototype for Many Derivatives:

The Gene Therapy Enterprise Has Generated Hundreds of Analogs

Self-Replicable and Therefore Selectable:

May be Able to Make and Improve Constructs Inexpensively.

DNA Topology Affects DNA Nanoconstructions

Chain Mail

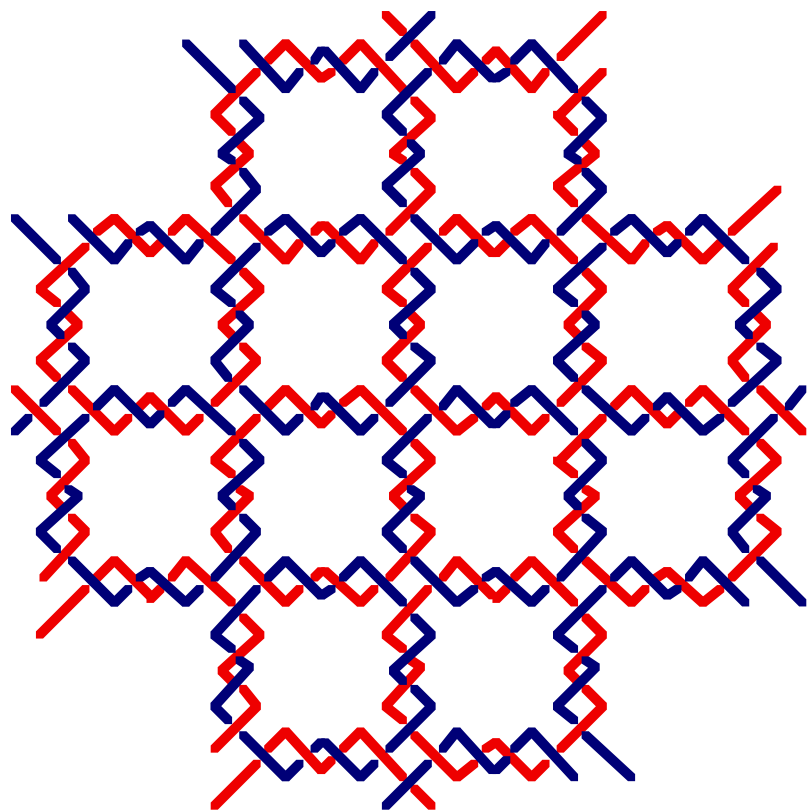

Interwoven

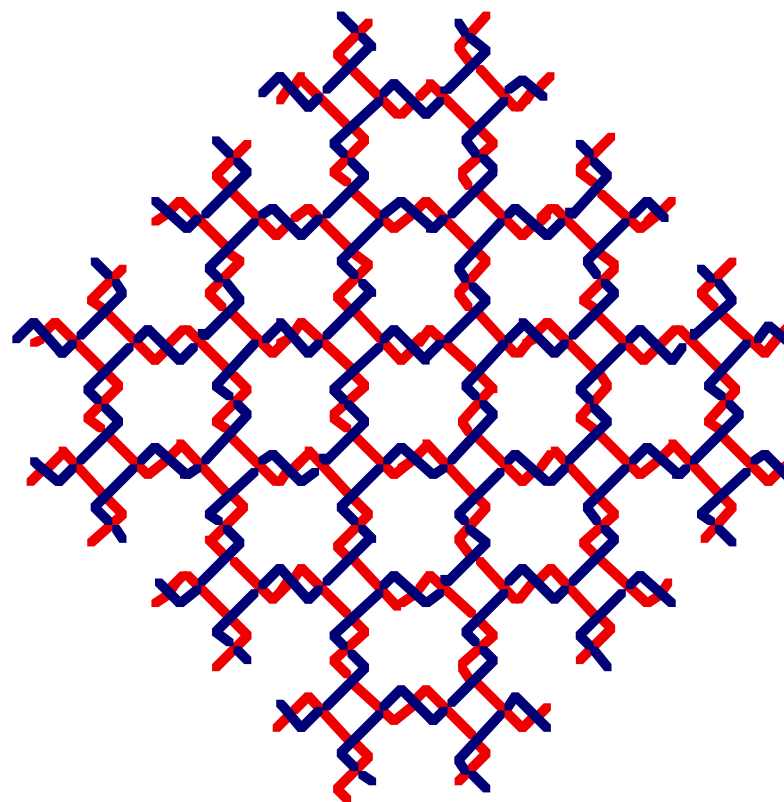

What Is the Intellectual Goal of Structural DNA Nanotechnology?

Controlling the Structure of Matter in 3D to the Highest Extent (Resolution) Possible, so as to Understand the Connection between the Molecular and Macroscopic Scales.

“What I cannot create, I do not understand.”

--Richard P. Feynman

(Inverse not necessarily true.)

STRUCTURAL AND TOPOLOGICAL ASSEMBLIES

Polyhedral Catenanes

Cube: Junghuei Chen

Truncated Octahedron: Yuwen Zhang

Cube





Truncated Octahedron

Zhang, Y. & Seeman, N.C. (1994),
J. Am. Chem. Soc. **116**, 1661-1669.

STRUCTURAL ASSEMBLIES



**Construction
of
Crystalline
Arrays**

REQUIREMENTS FOR LATTICE DESIGN COMPONENTS

PREDICTABLE INTERACTIONS

PREDICTABLE LOCAL PRODUCT STRUCTURES

STRUCTURAL INTEGRITY



Derivation of DX and TX Molecules

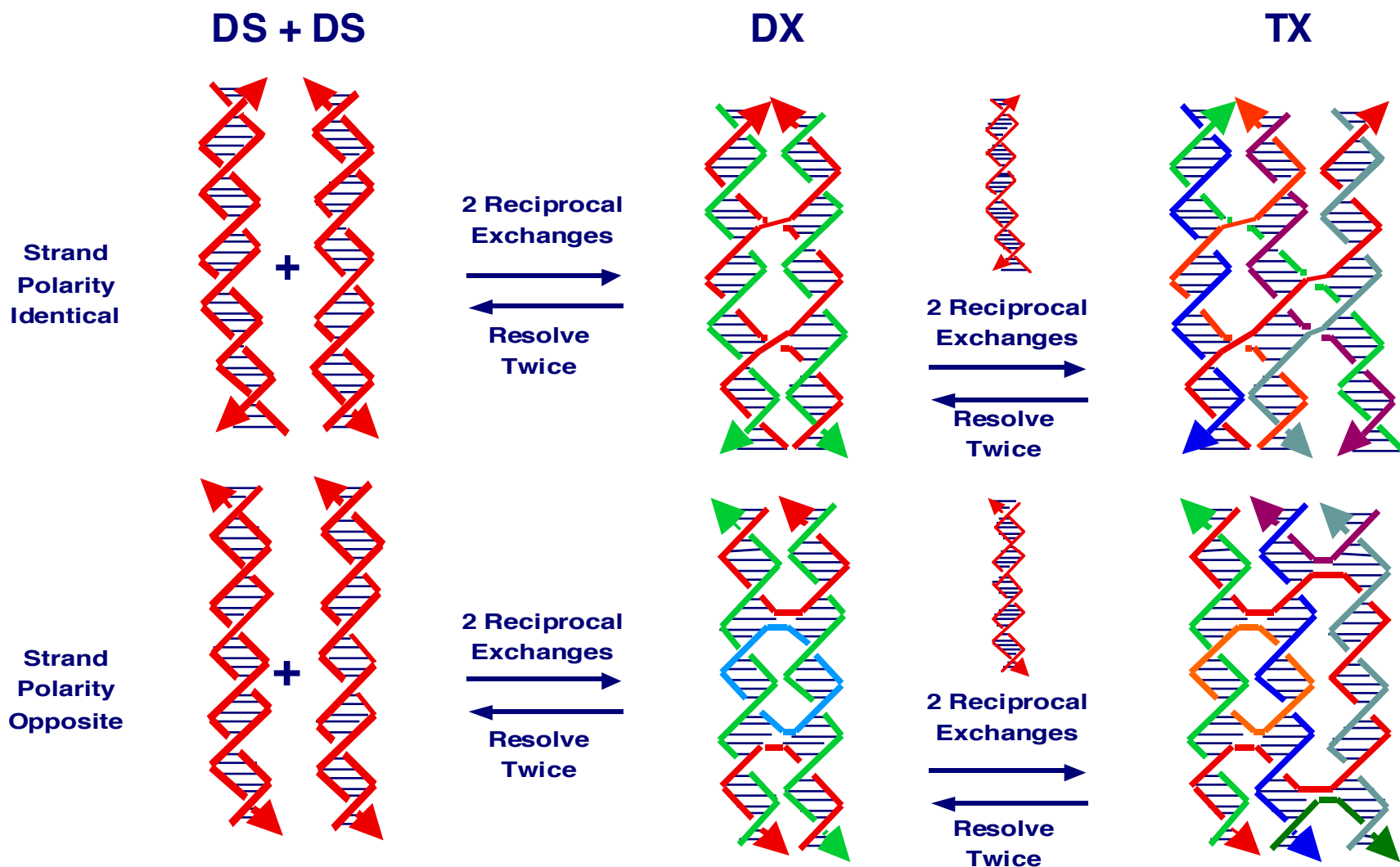

2D DX Arrays

Erik Winfree (Caltech)

Furong Liu

Lisa Wenzler

Schematic of a Lattice Containing 1 DX Tile and 1 DX+J Tile

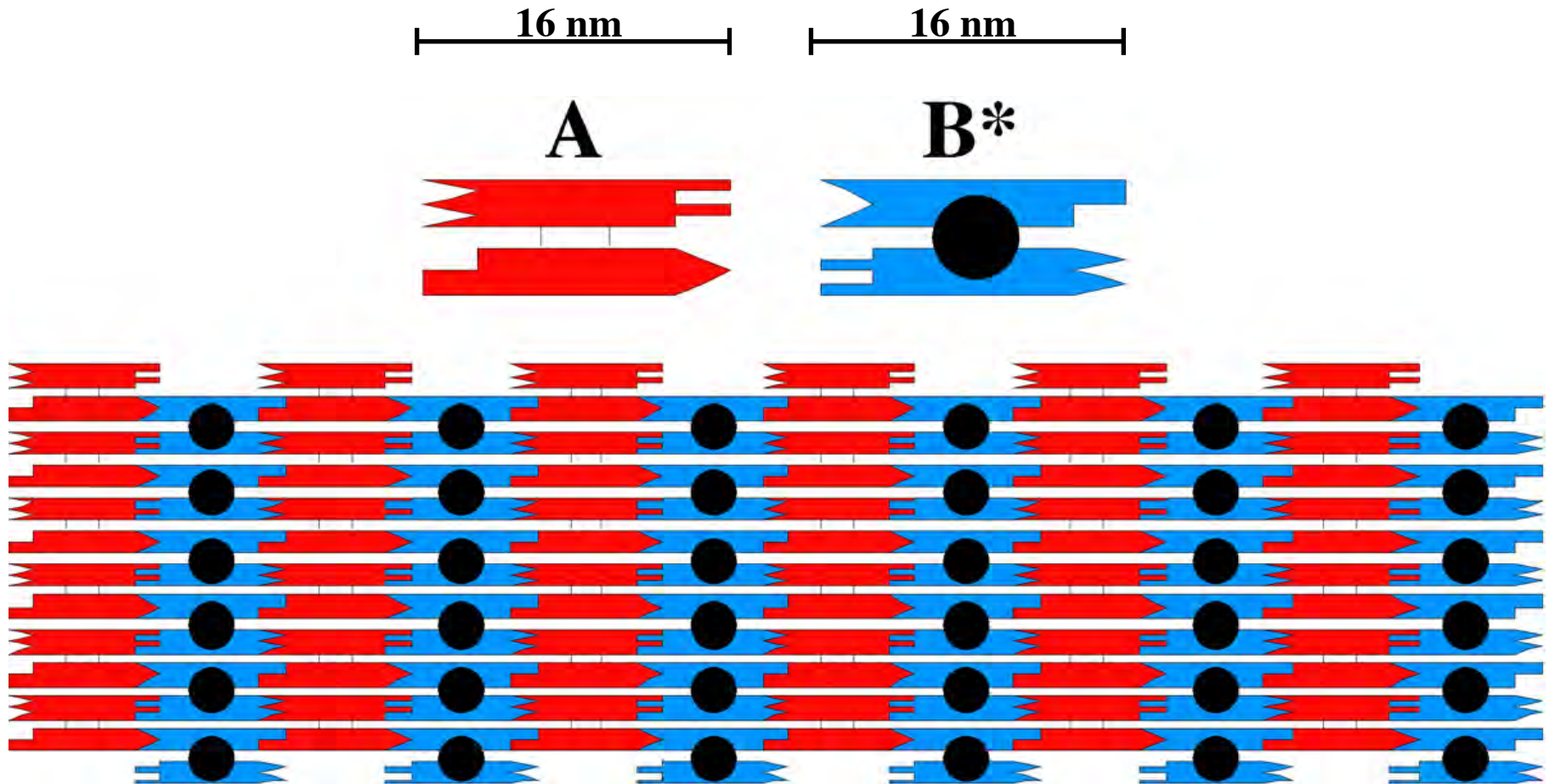

AFM of a Lattice Containing 1 DX Tile and 1 DX+J Tile

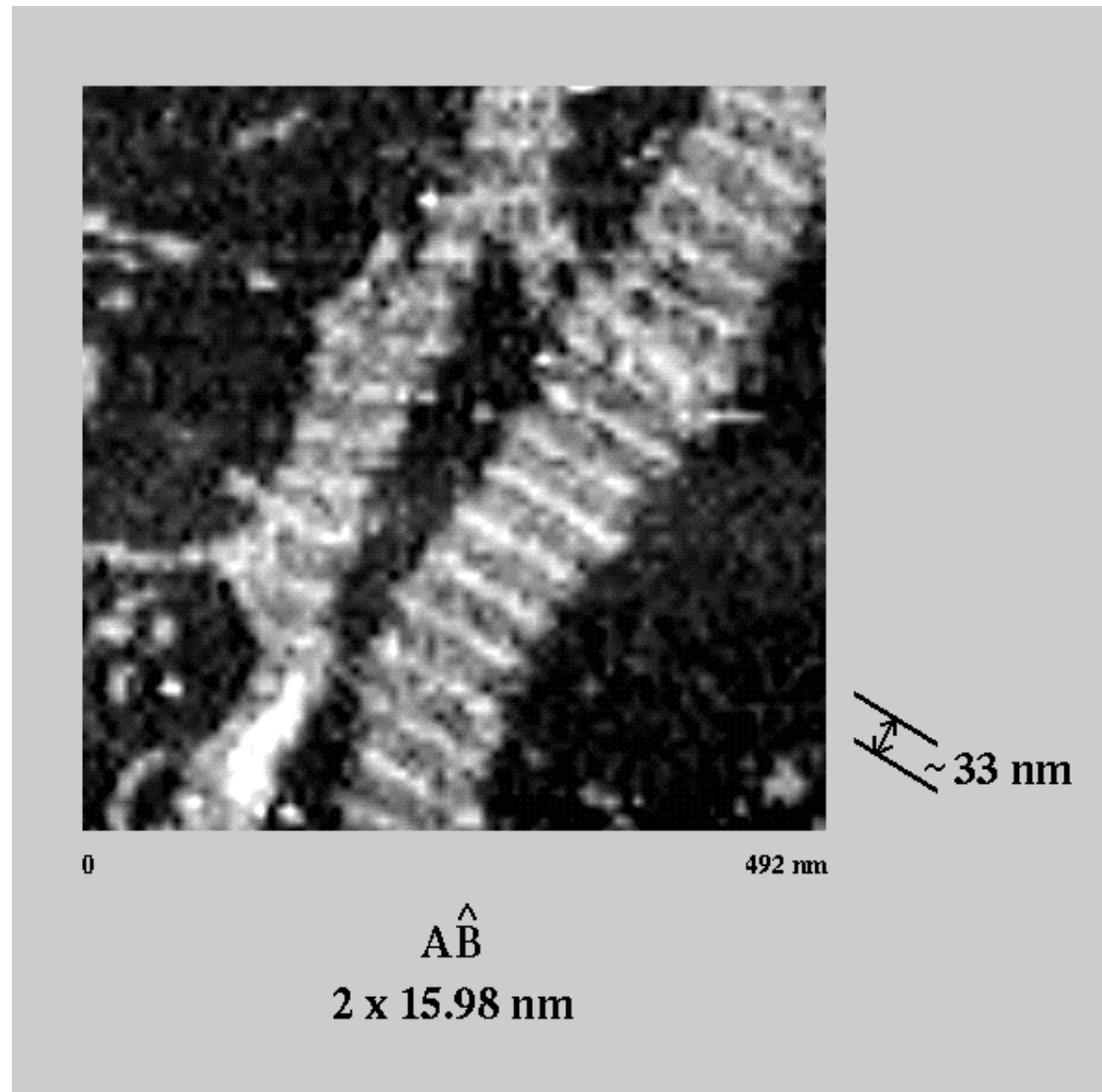

Schematic of a Lattice Containing 3 DX Tiles and 1 DX+J Tile

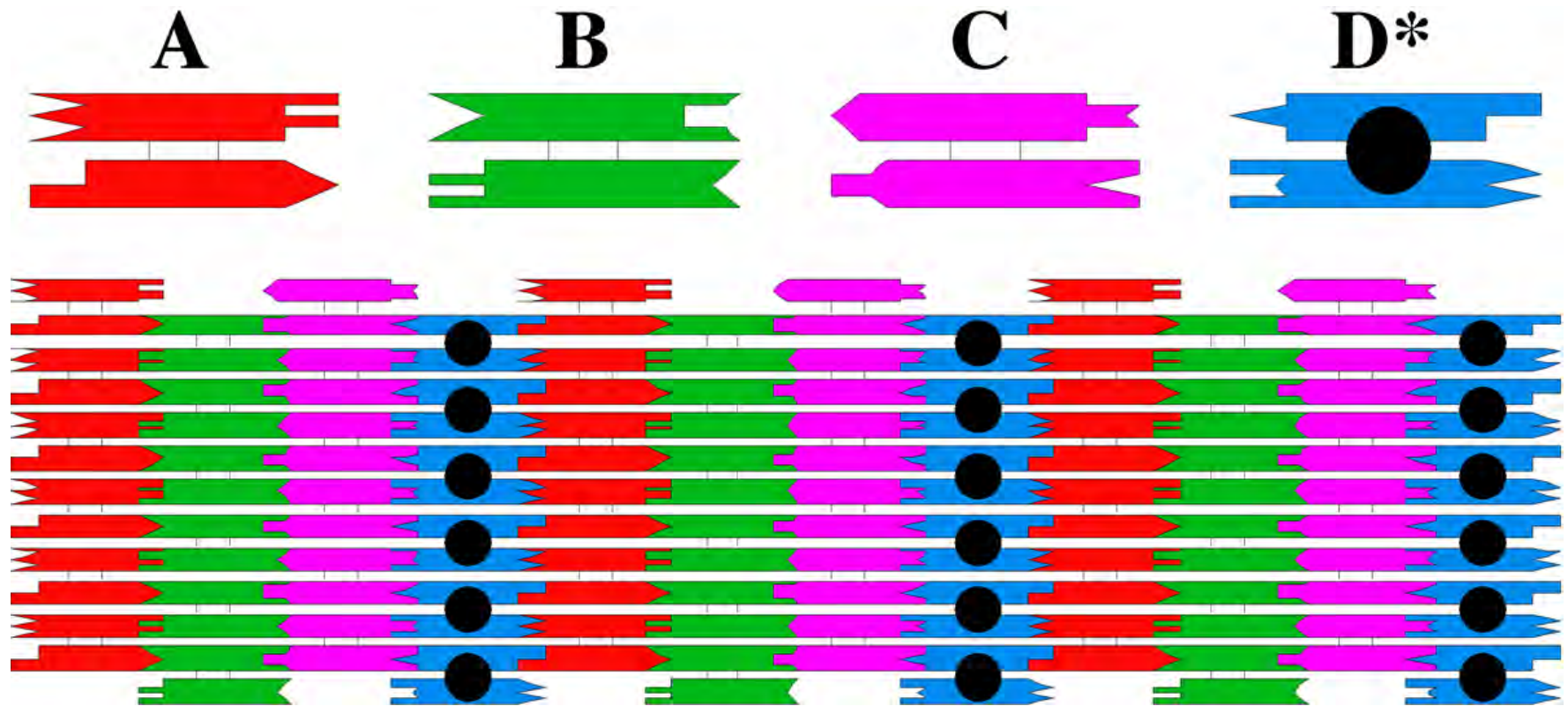

AFM of a Lattice Containing 3 DX Tiles and 1 DX+J Tile

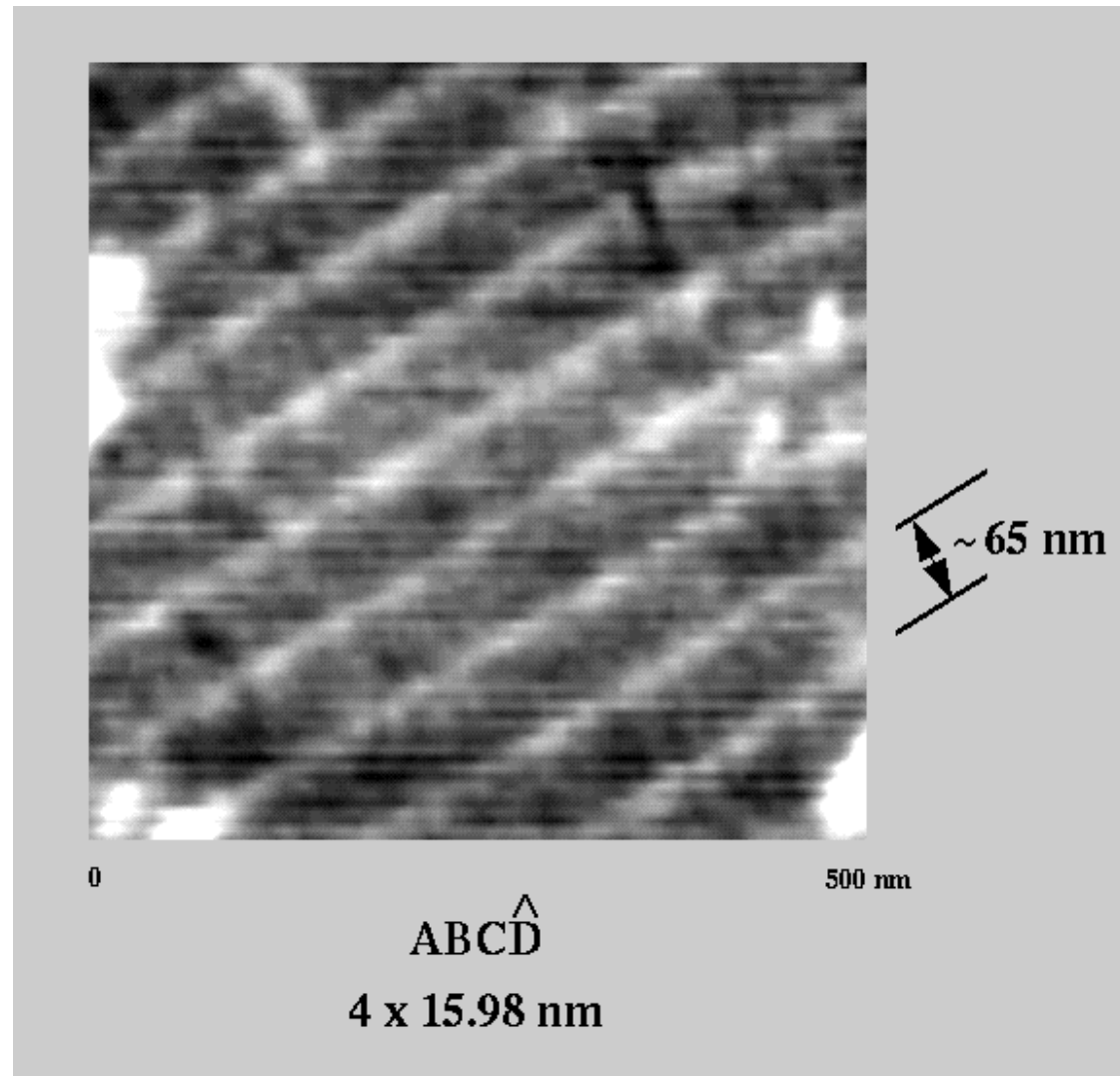

Winfrey, E., Liu, F., Wenzler, L.A. & Seeman, N.C. (1998), *Nature* **394**, 539-544.

Three-Dimensional Self-Assembled Arrays: DESIGNED CRYSTALS!

**Jianping Zheng, Jens J. Birktoft, Yi Chen (Purdue),
Tong Wang, Ruojie Sha, Pam Constantinou,
Steve Ginell (Argonne), Chengde Mao (Purdue)**

**Diffraction Data Collected at
Brookhaven National Laboratory (NSLS) and
Argonne National Laboratory (APS)**

A 3D DNA Tensegrity Triangle

[D.Liu, M. Wang, Z. Deng, R. Walulu & C.Mao, *J. Am. Chem. Soc.* **126**, 2324-2325 (2004)]

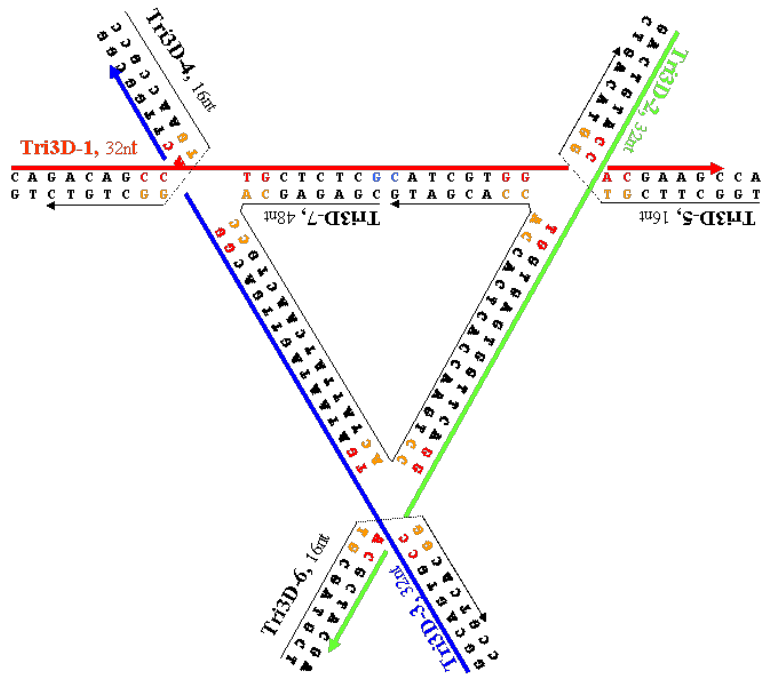

**X-Ray Diffraction:
Predicted Spacings and
Rhombohedral Symmetry
Resolution: ~10Å**

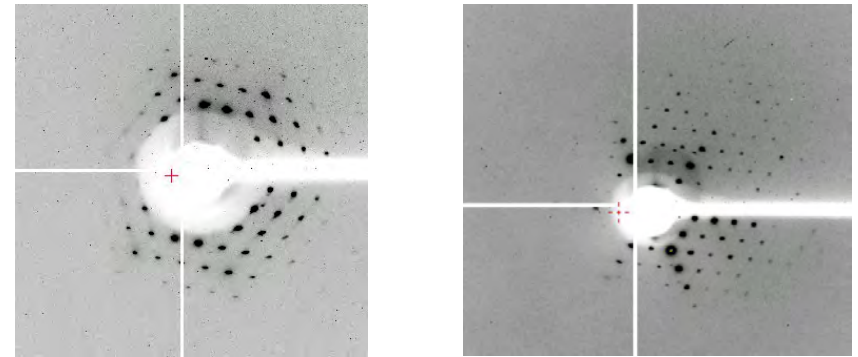

Designed 142 Å Edges

The Tensegrity Triangle Motif



A Small Threefold Pseudosymmetric DNA Tensegrity Triangle

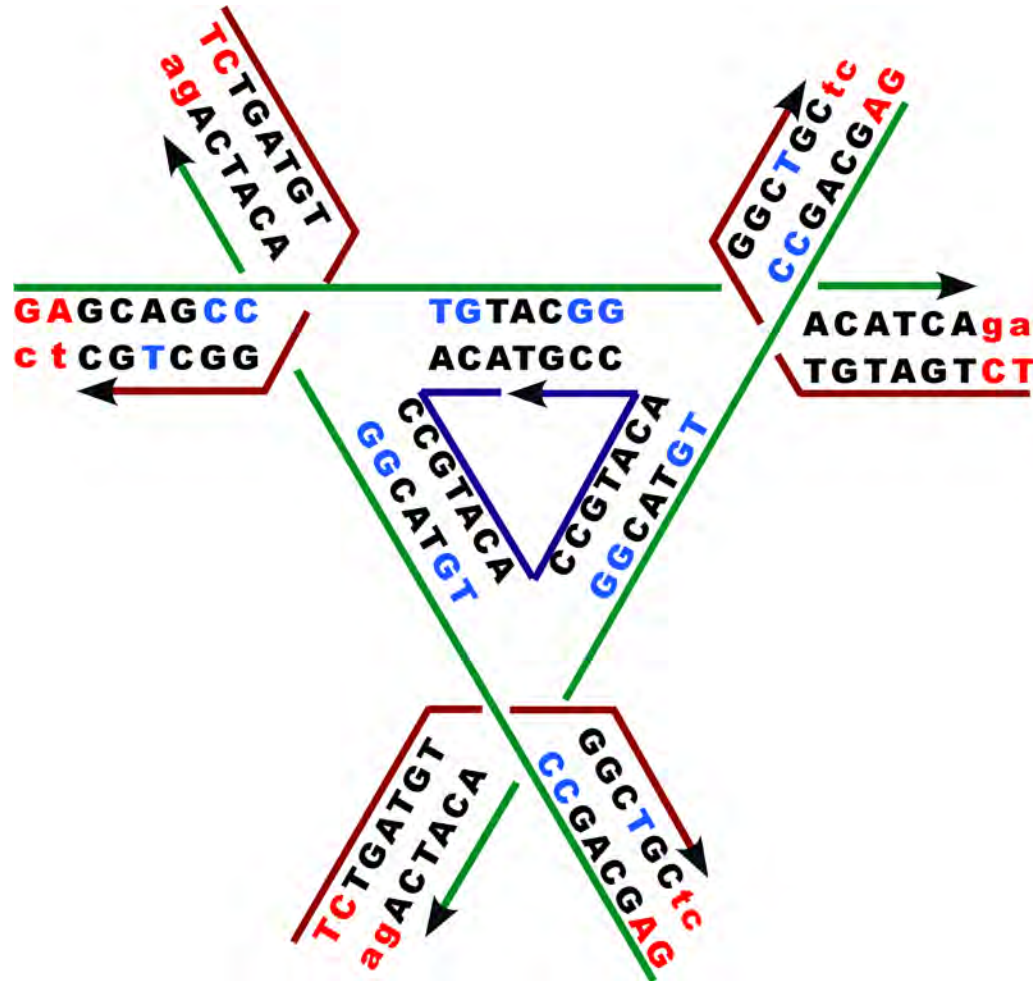

J. Zheng, J.J. Birktoft, Y. Chen, T. Wang, R. Sha,
P.E. Constantinou, S.L. Ginell, C. Mao & N.C. Seeman, *Nature* 461, 74-77 (2009).

Crystal Images

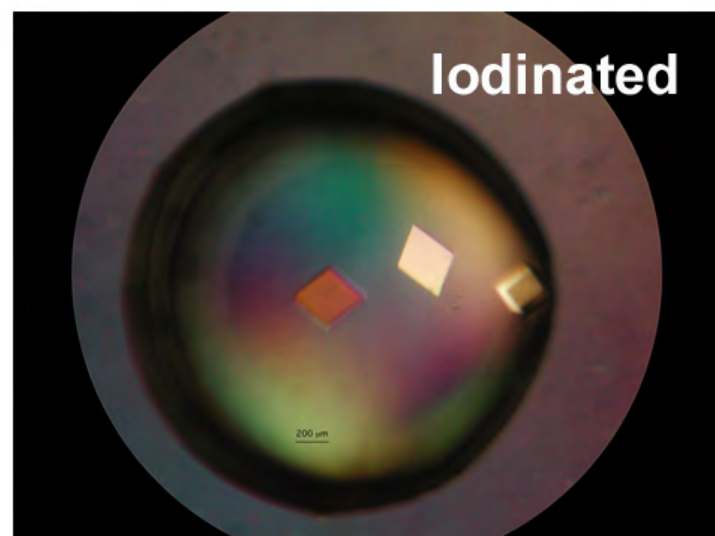
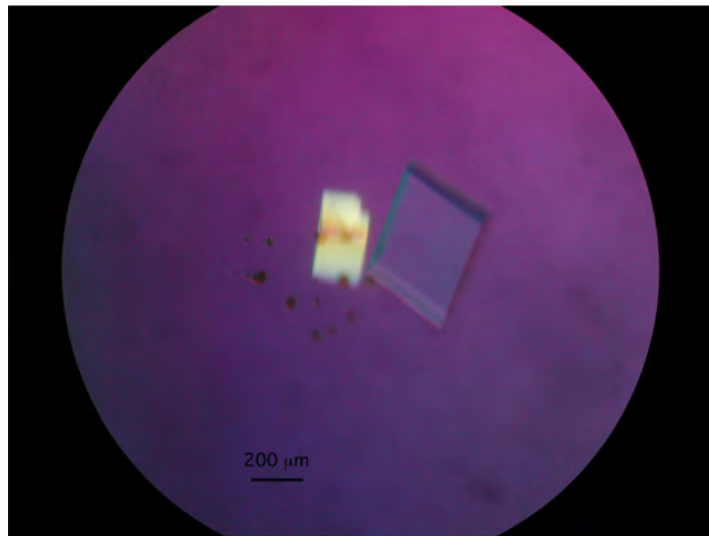
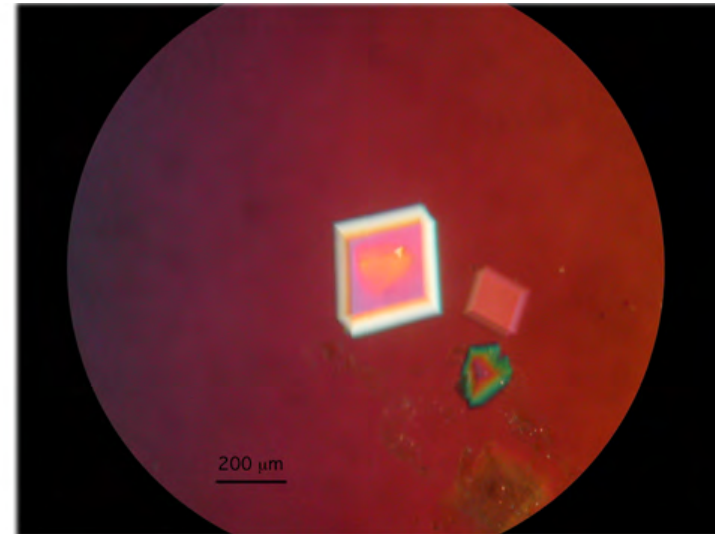
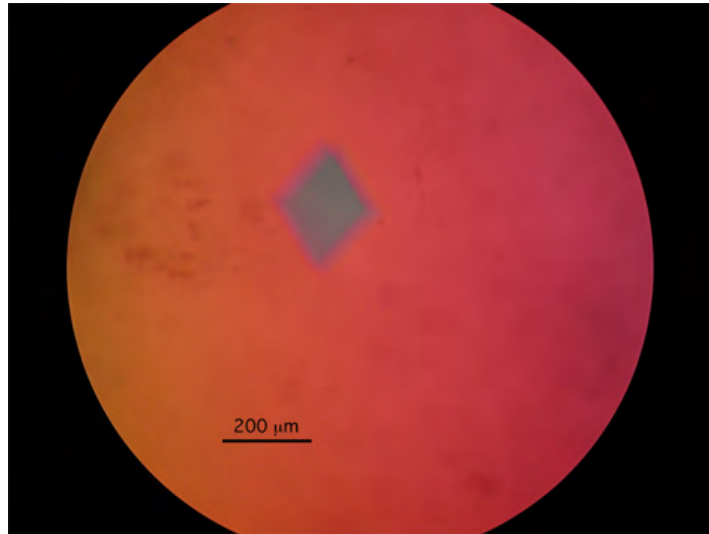

J. Zheng, J.J. Birktoft, Y. Chen, T. Wang, R. Sha, P.E. Constantinou, S.L. Ginell, C. Mao & N.C. Seeman, *Nature* 461, 74-77 (2009).

Crystal Structure of the 2-Turn DNA Tensegrity Triangle

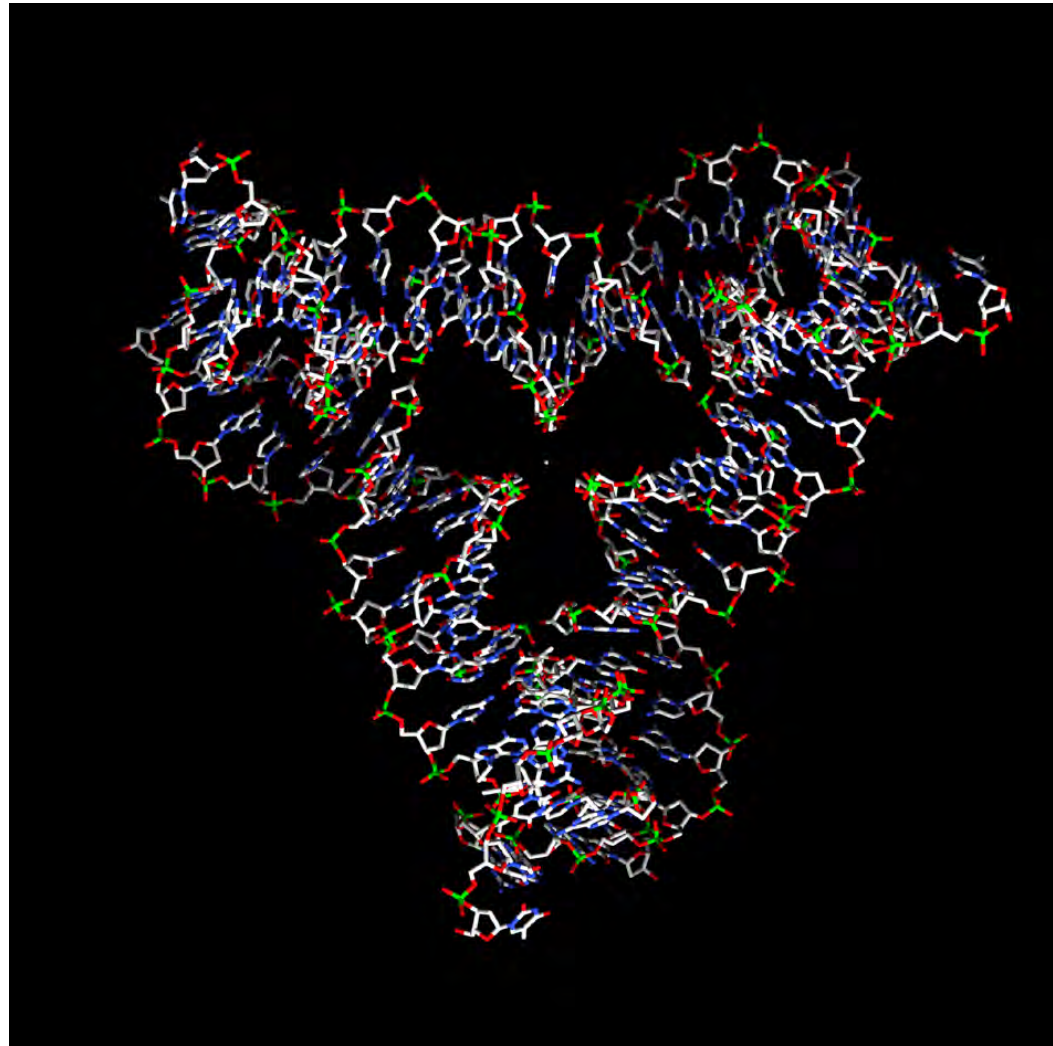

J. Zheng, J.J. Birktoft, Y. Chen, T. Wang, R. Sha,
P.E. Constantinou, S.L. Ginell, C. Mao & N.C. Seeman, *Nature* 461, 74-77 (2009).

4 Å [APS] Map Perpendicular to a Helix

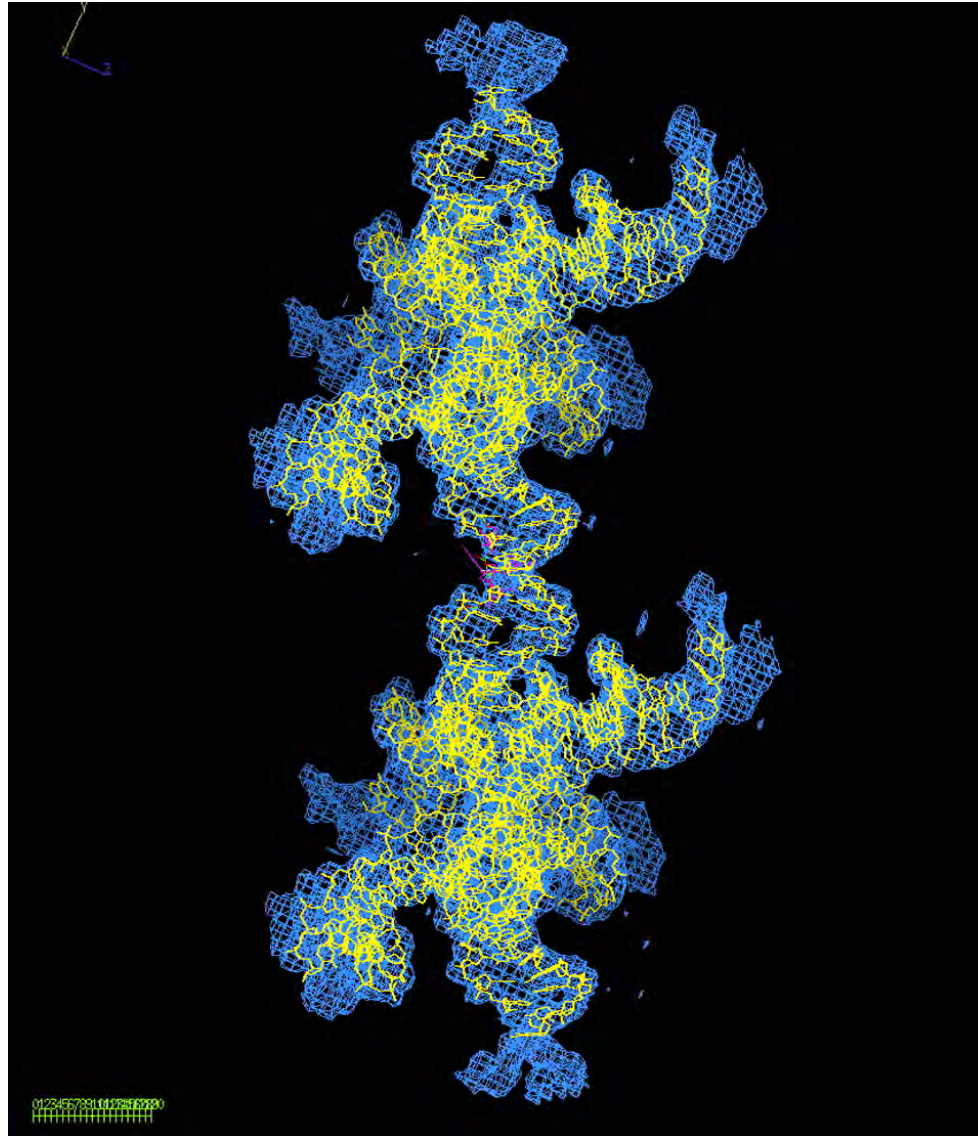

J. Zheng, J.J. Birktoft, Y. Chen, T. Wang, R. Sha,
P.E. Constantinou, S.L. Ginell, C. Mao & N.C. Seeman, *Nature* 461, 74-77 (2009).

Environment of a Single Triangle

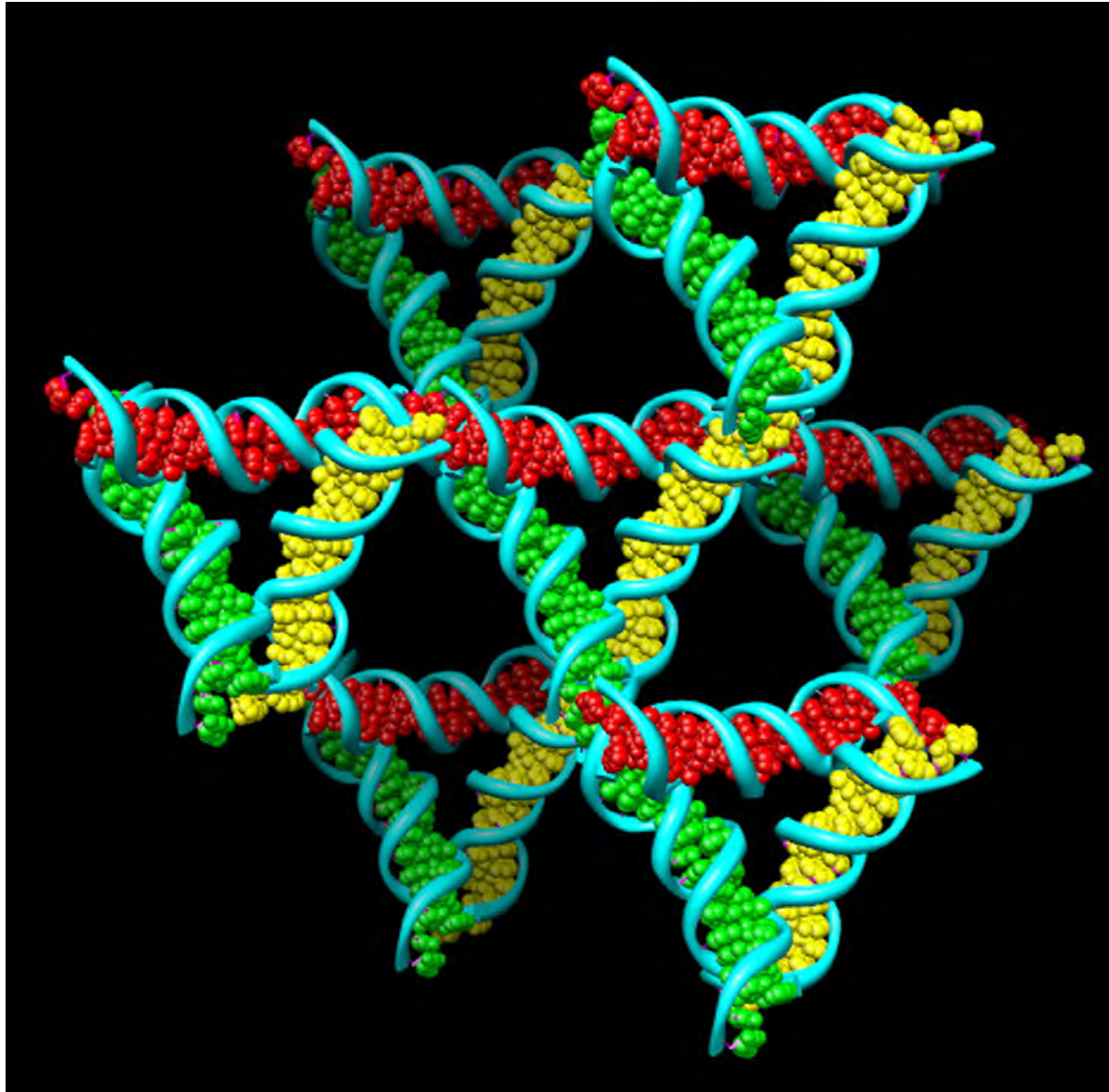

J. Zheng, J.J. Birktoft, Y. Chen, T. Wang, R. Sha,
P.E. Constantinou, S.L. Ginell, C. Mao & N.C. Seeman, *Nature* 461, 74-77 (2009).

The Rhombohedral Cavity

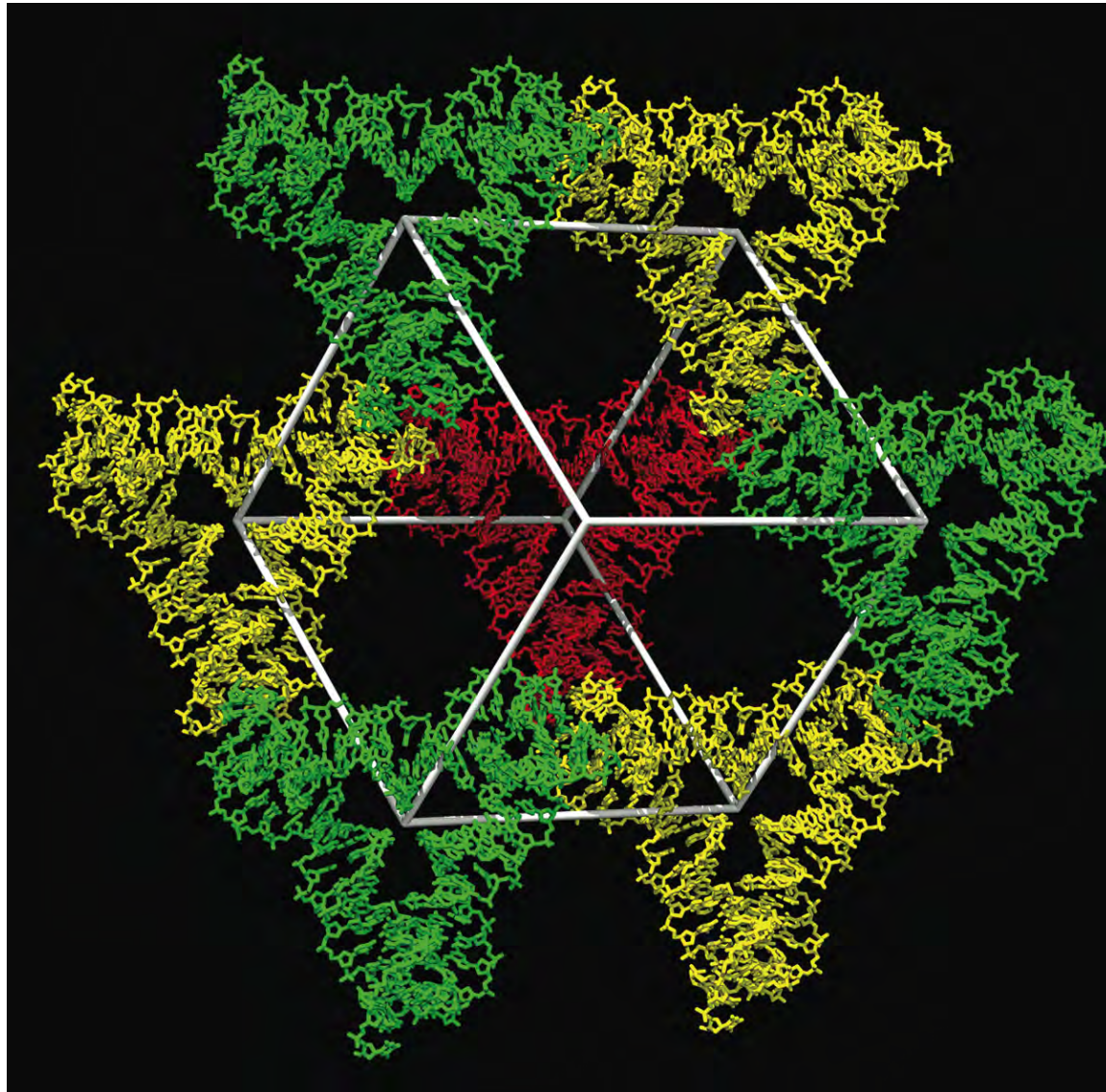

J. Zheng, J.J. Birktoft, Y. Chen, T. Wang, R. Sha,
P.E. Constantinou, S.L. Ginell, C. Mao & N.C. Seeman, *Nature* 461, 74-77 (2009).

Mono View Down 3-Fold Axis

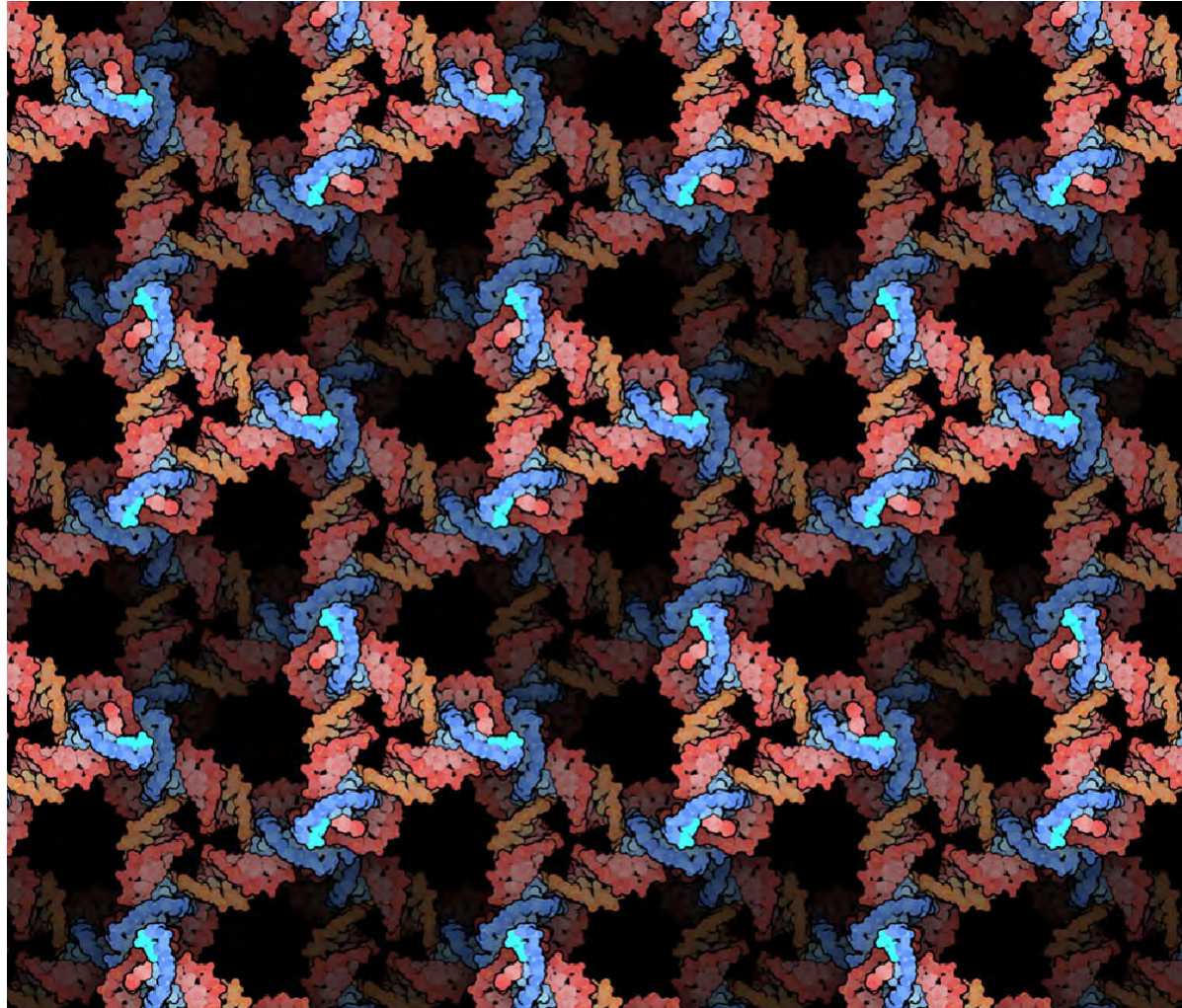

R3; $\underline{\mathbf{a}} = 68.28 \text{ \AA}$; $\alpha = 102.44^\circ$

Image Courtesy of
David Goodsell

J. Zheng, J.J. Birktoft, Y. Chen, T. Wang, R. Sha,
P.E. Constantinou, S.L. Ginell, C. Mao & N.C. Seeman, *Nature* 461, 74-77 (2009).

Table 1. Crystalline Tensegrity Triangles

Edge Length	Symmetry	Inter-junction Pairs	Rhombohedral Cell Dimensions	Resolution (Å)	Cross Section (nm ²)	Cavity Size (nm ³)
21	+	7	a = 68.3, $\alpha = 102.4^\circ$	4.0	23	103
21	-	7	a = 68.0, $\alpha = 102.6^\circ$	5.0	23	101
31	+	17	a = 102.0, $\alpha = 112.7^\circ$	6.1	62	366
31	-	17	a = 100.9, $\alpha = 111.6^\circ$	6.3	61	373
32	+	18	a = 103.6, $\alpha = 113.6^\circ$	6.5	64	367
32	-	18	a = 103.3, $\alpha = 112.2^\circ$	6.5	64	395
42	+	17	a = 134.9, $\alpha = 110.9^\circ$	11.0	123	1104
42	-	17	a = 133.7, $\alpha = 111.3^\circ$	14.0	120	1048
42	+	28	a = 134.9, $\alpha = 117.3^\circ$	10.0	117	643

J. Zheng, J.J. Birktoft, Y. Chen, T. Wang, R. Sha, P.E. Constantinou, S.L. Ginell, C. Mao & N.C. Seeman, *Nature* 461, 74-77 (2009).

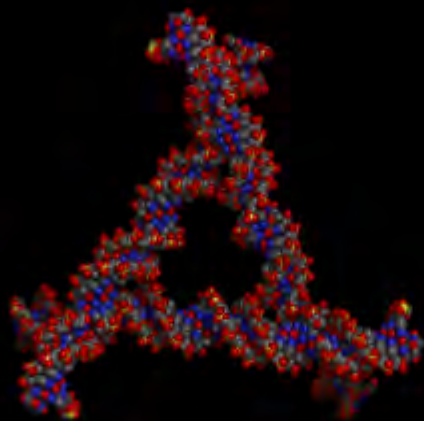

Movie Courtesy of Kevin Drew

A Two-Turn Tensegrity Triangle Designed Lattice with Two Components

Tong Wang

Ruojie Sha

Jens Birktoft

Jianping Zheng

Chengde Mao (Purdue)

Movie of the Rhombohedral Cavity

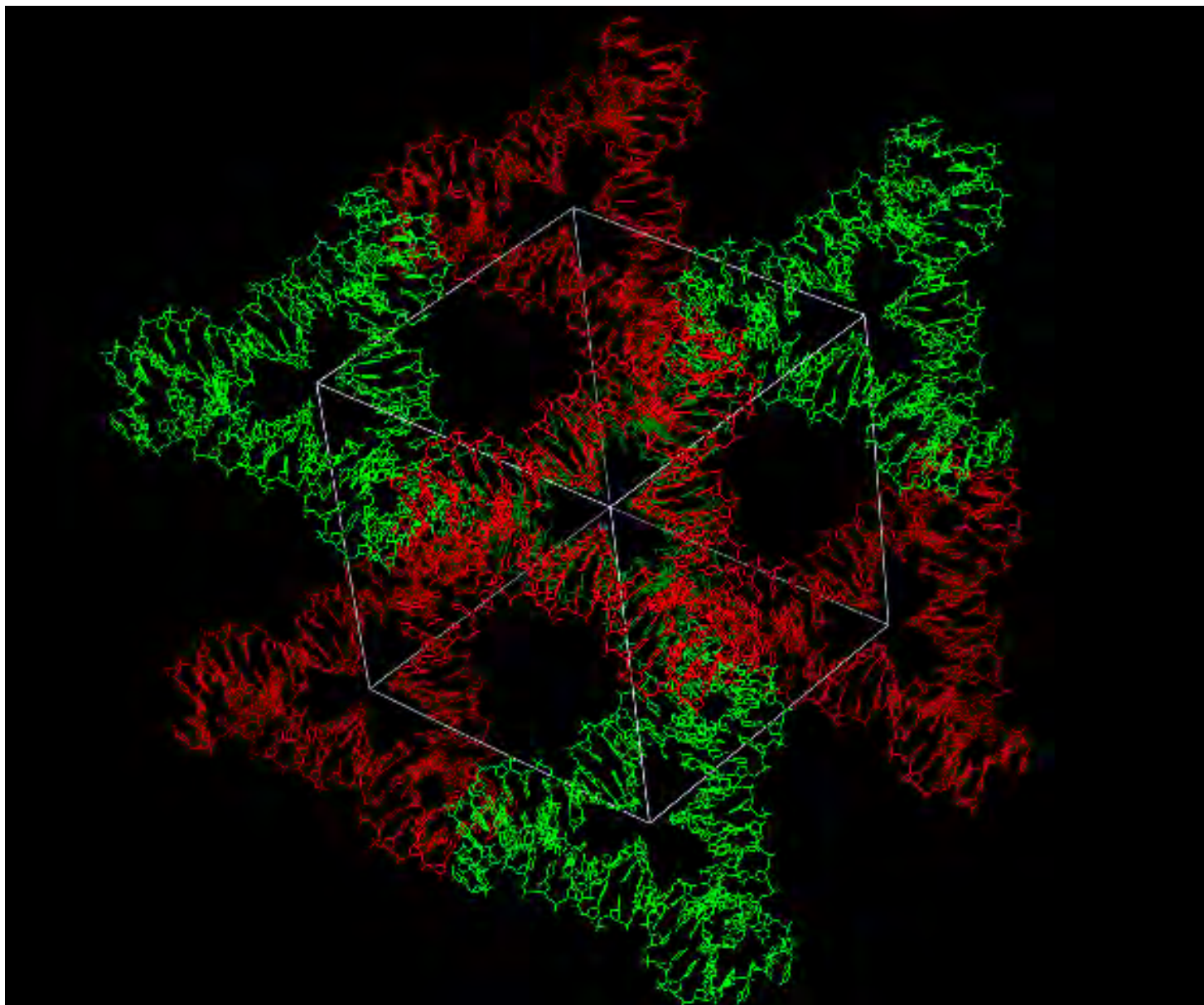

T.Wang, R. Sha, J.J. Birktoft, J. Zheng, C. Mao, N.C. Seeman, *J. Am. Chem. Soc.*, in press (2010).

**Covalent Attachment of
Fluorescent Dyes
to One or Two Triangles
in the A•B Crystal**

Ruojie Sha

Attachment of Cy3 & Cy5 to Triangles

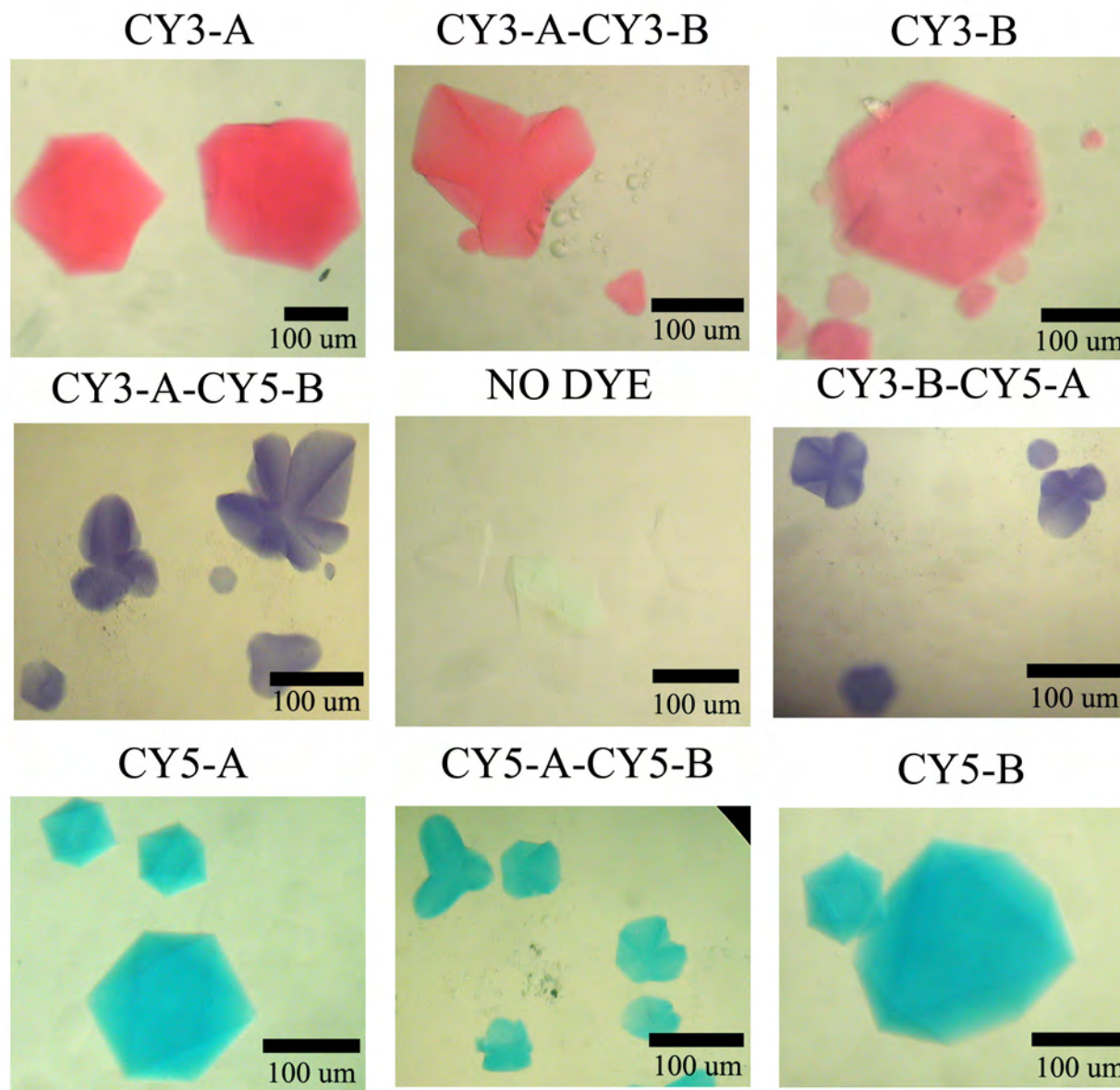

Nanocrystals Diffract Better than 4Å

Arun Richard Chandrasekaran

Yoel Ohayon

Ilme Schlichting

Petra Fromme

Henry Chapman

+ 30 Others

SE = 1, No PO₄

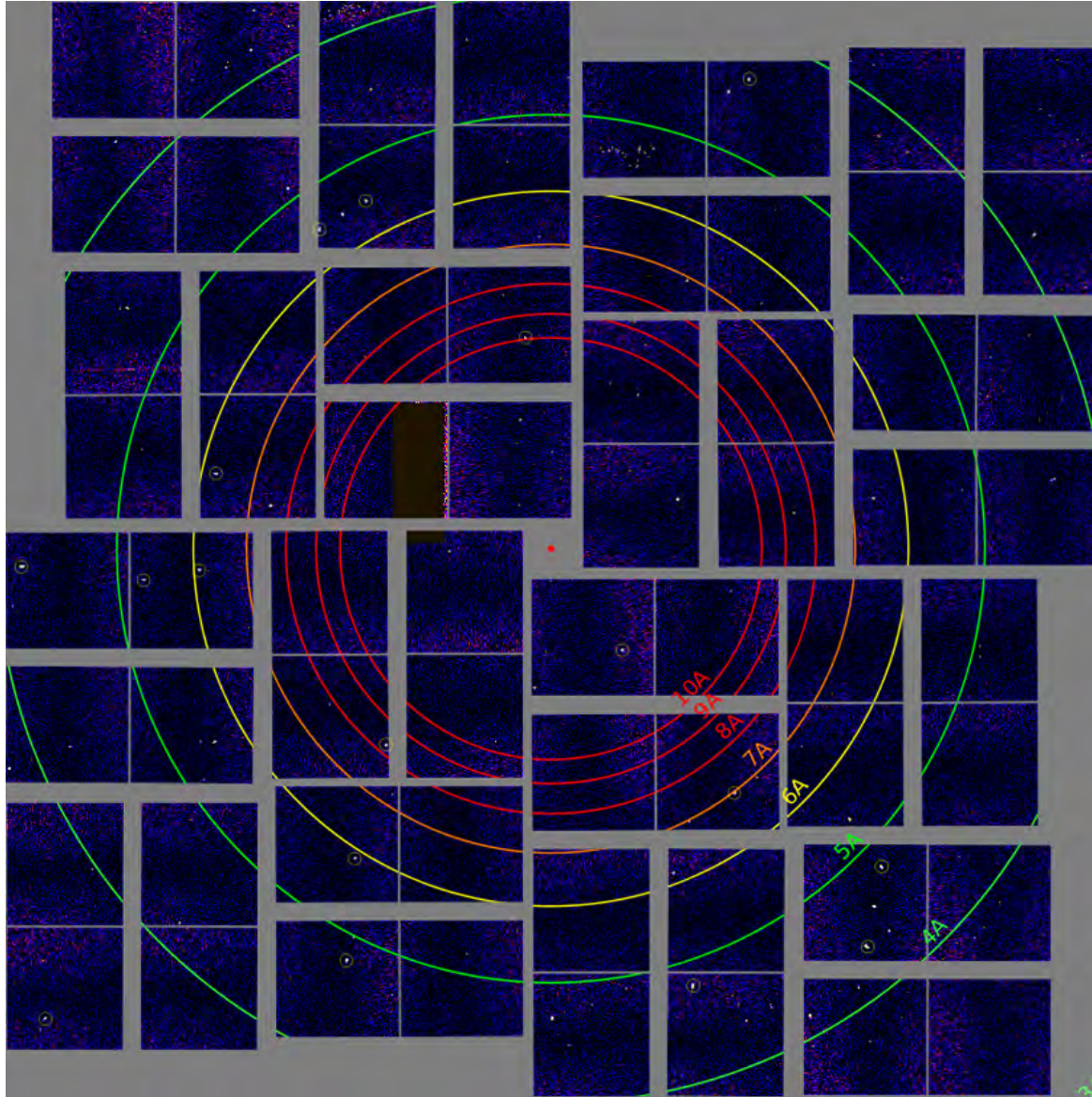

Modifying Contacts Improves Resolution to 3.0 Å at NSLS

Arun Richard Chandrasekaran

Yoel Ohayon

Nam Nguyen

Jens Birktoft

Ruojie Sha

SE = 1 G:C, All Strands Contain 5' PO₄

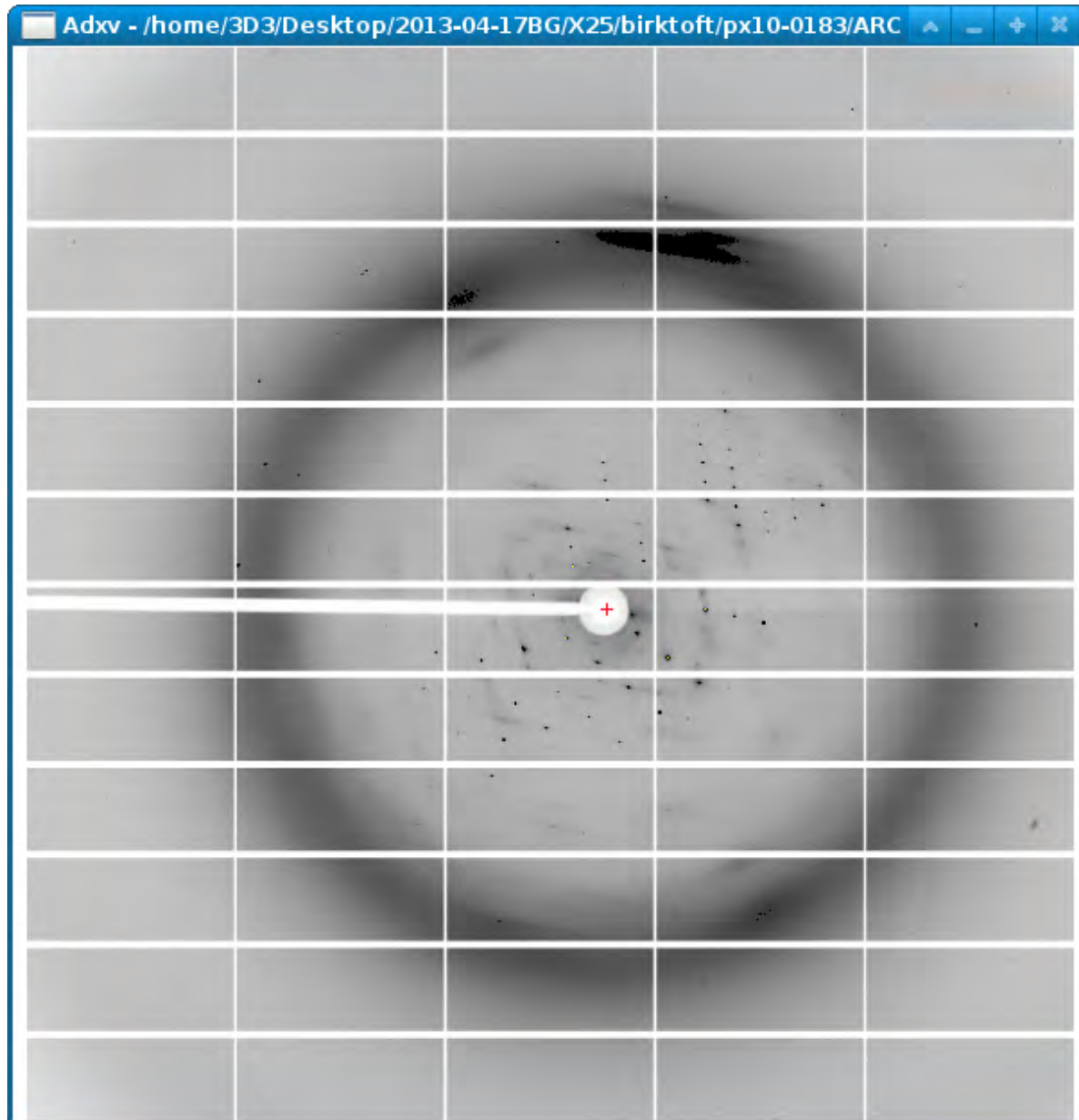

FROM GENES TO MACHINES

SHAPE-SHIFTERS



B-Z Device

Chengde Mao

A Device Based on the B \leftrightarrow Z Transition

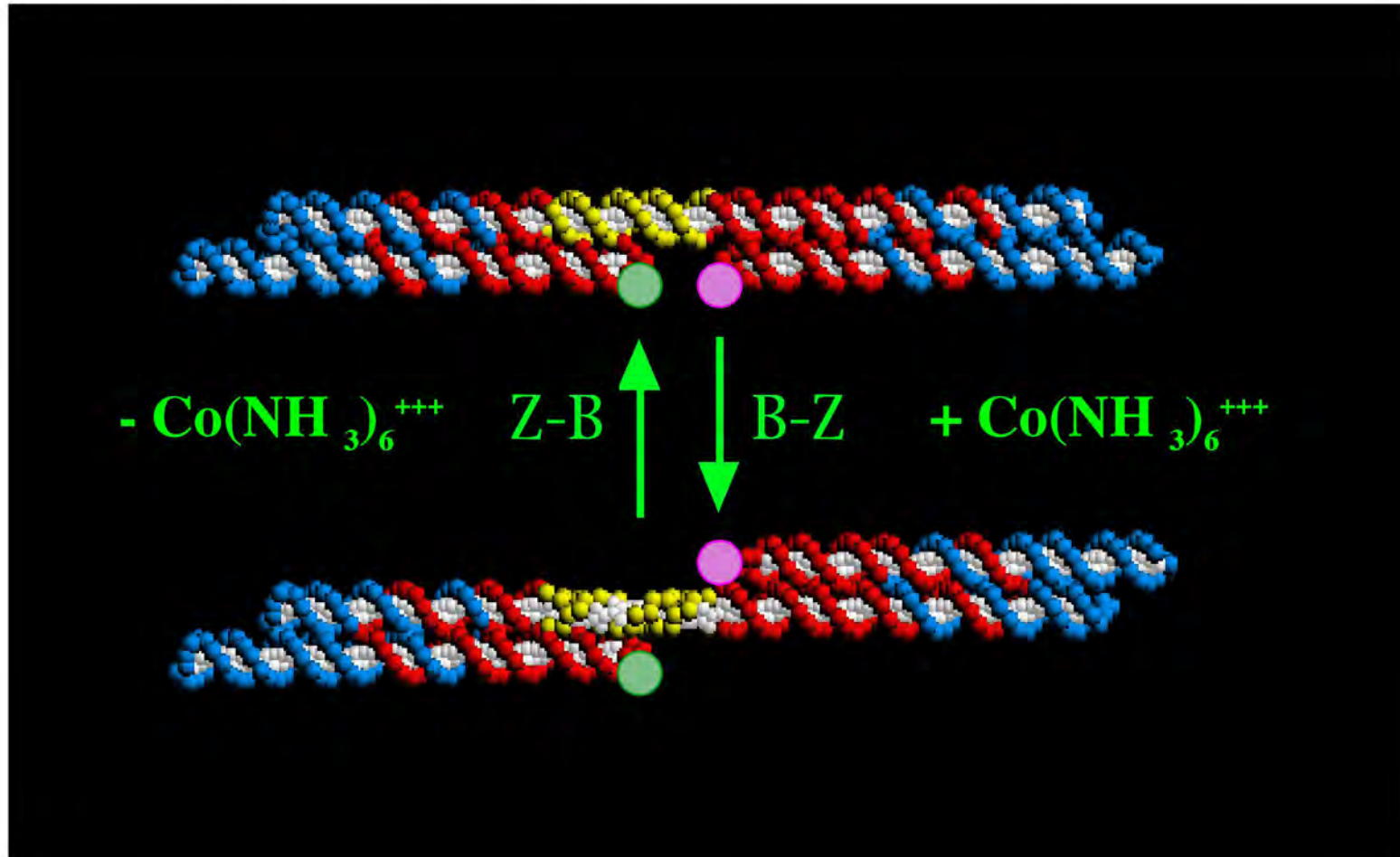

A Sequence-Dependent Device

Hao Yan

Derivation of PX DNA

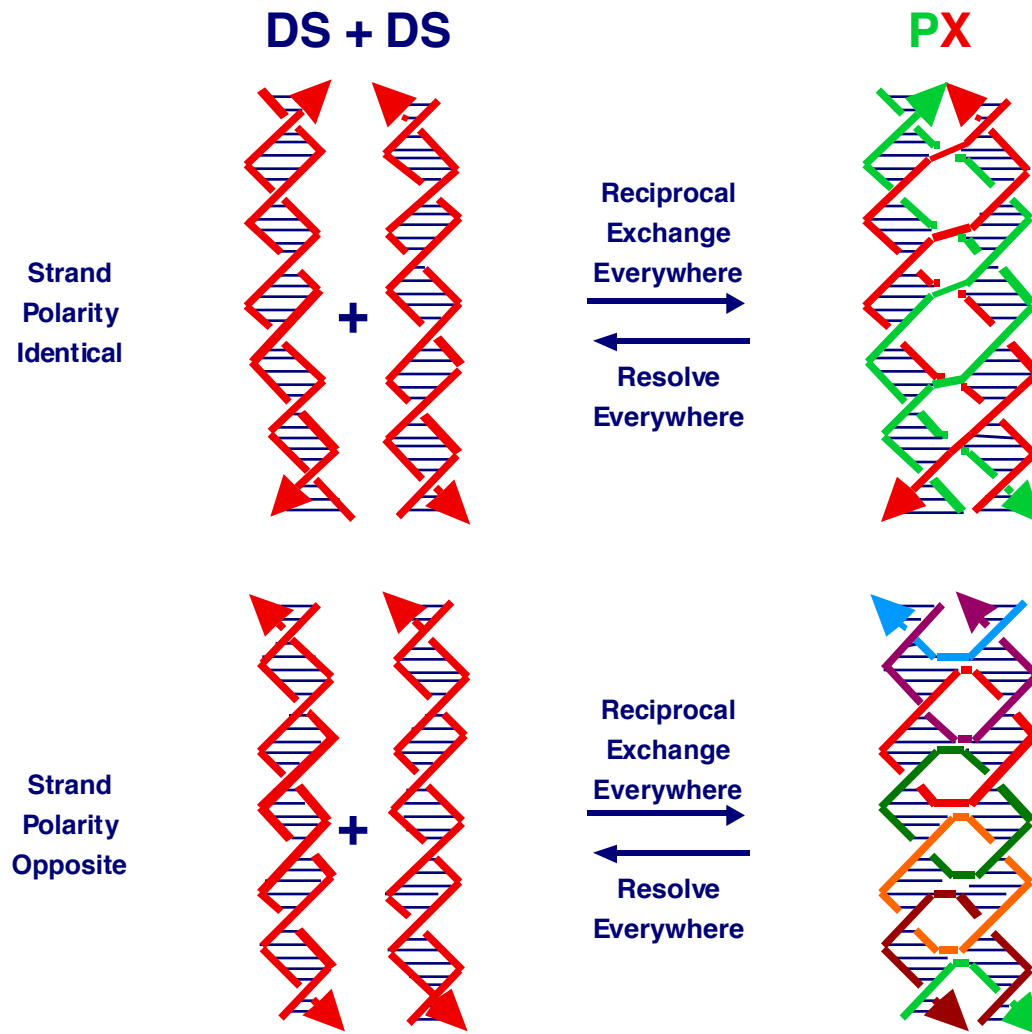

PX

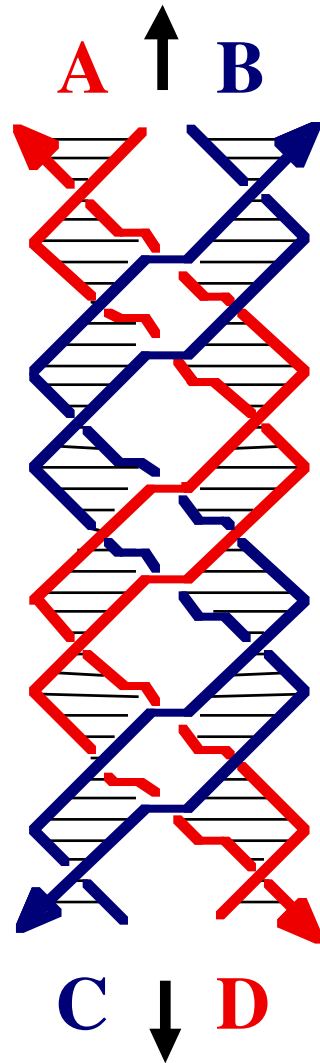

JX₂

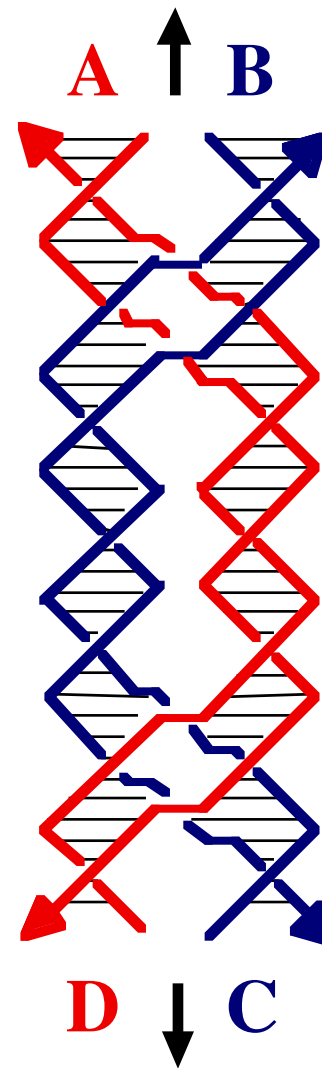

Switchable Versions of PX and JX₂

PX

JX₂

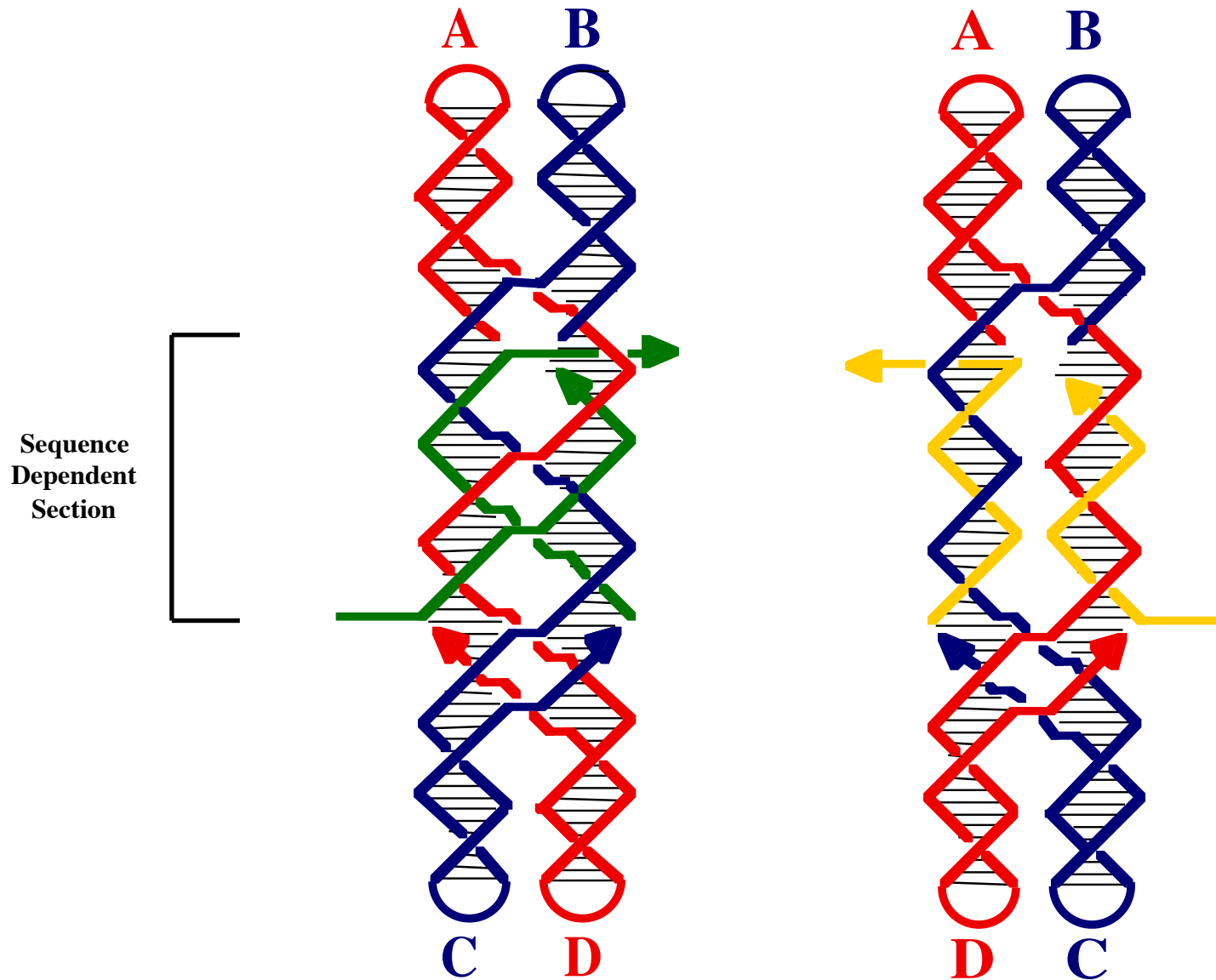

Machine Cycle of the PX-JX₂ Device

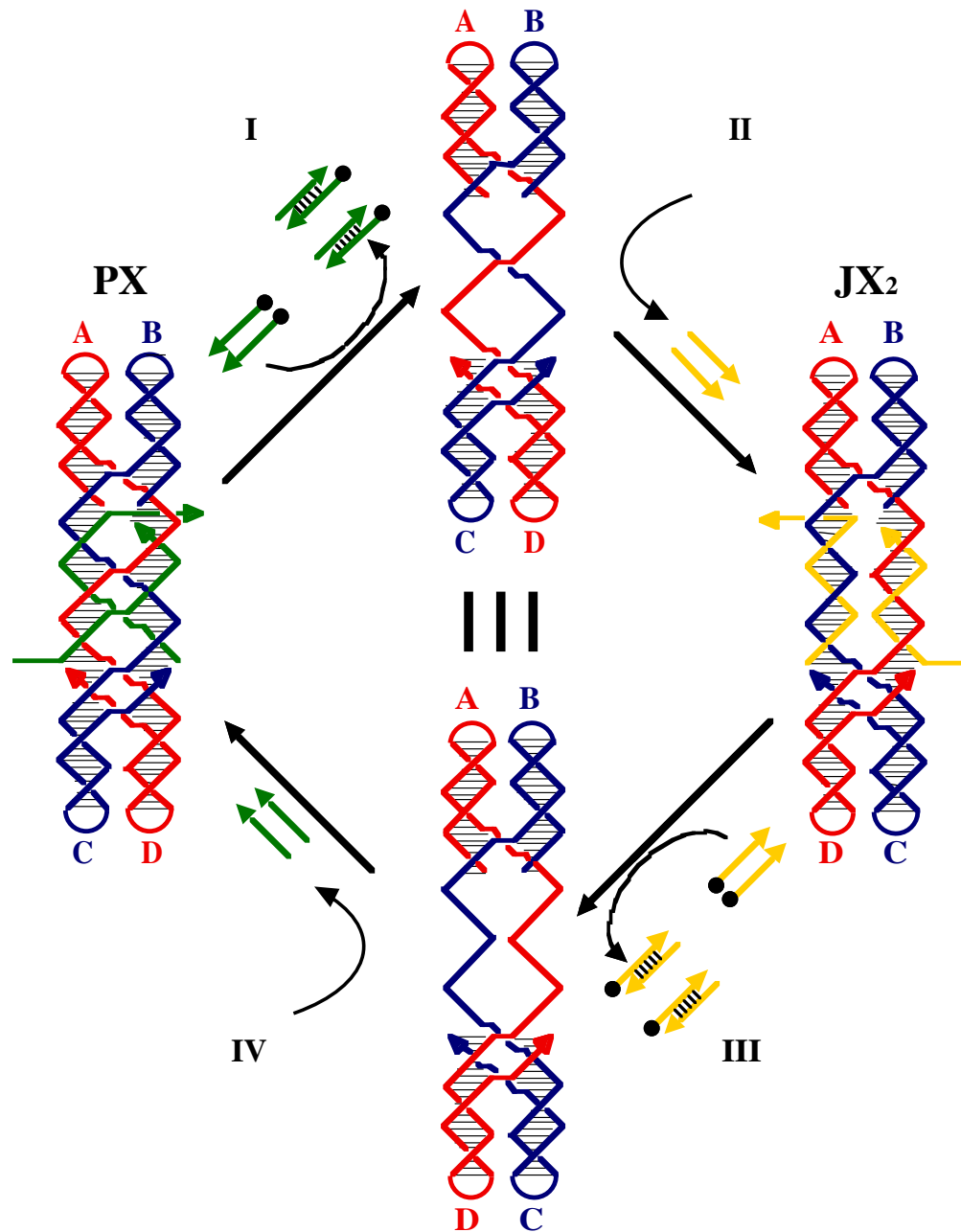

System to Test the PX-JX₂ Device

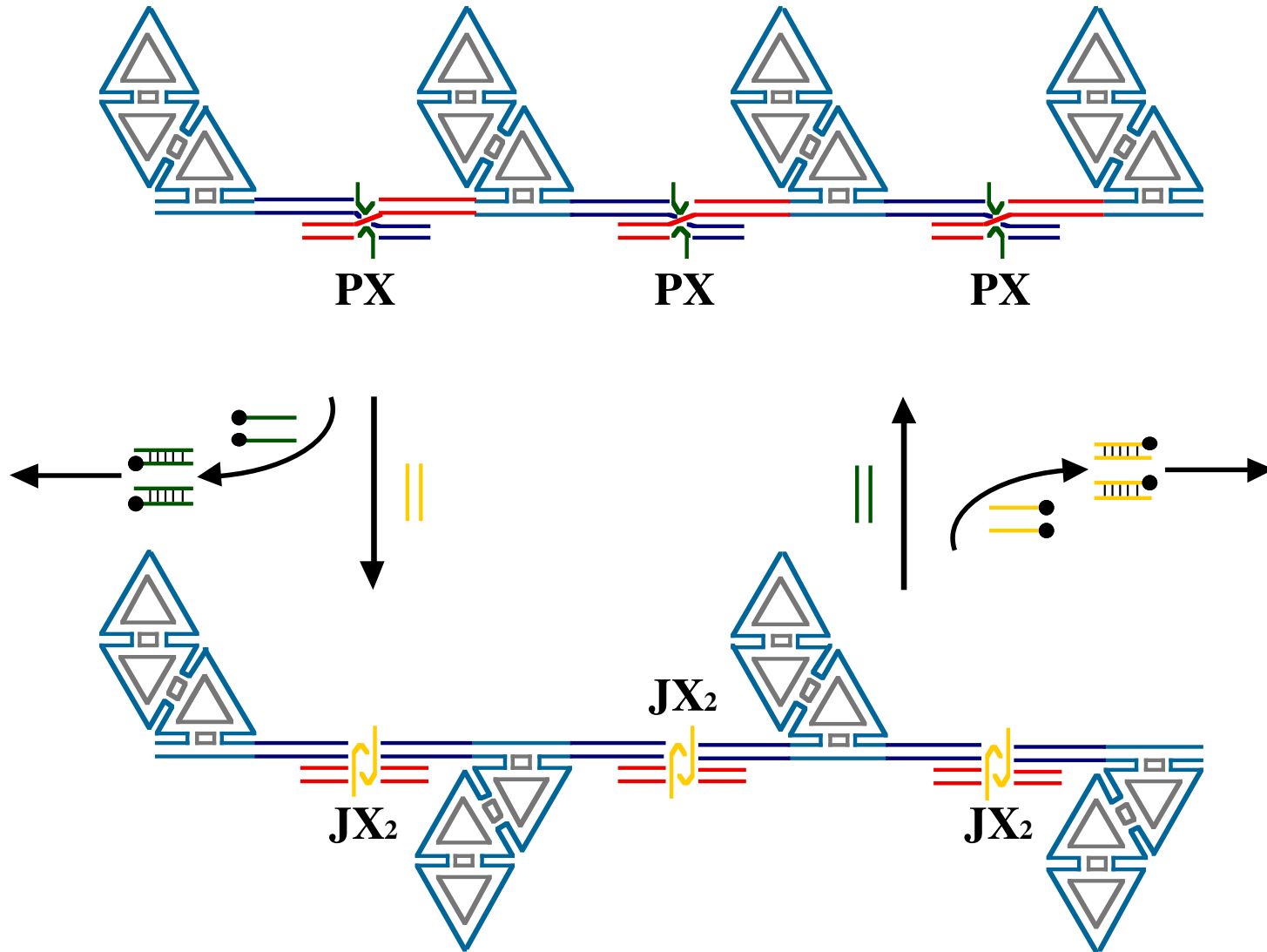

AFM Evidence for Operation of the PX-JX₂ Device

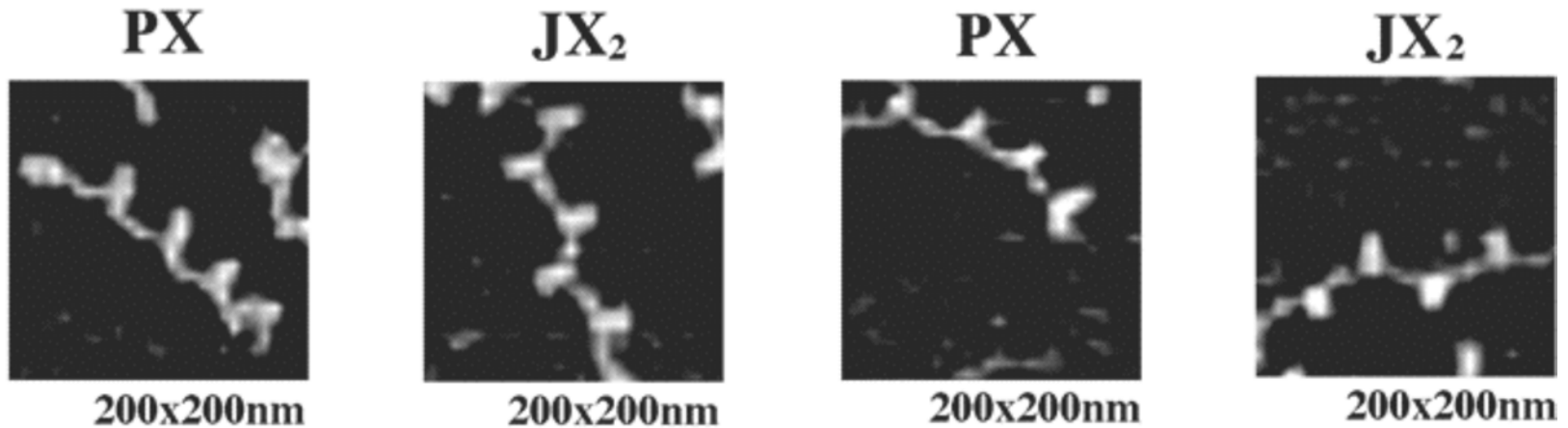

WALKERS

DNA Walking Biped

Bill Sherman

INCHWORM



Animation of the Biped Walker



Courtesy of Ann Marie Cunningham and Donna Vaughn of ScienCentral News

DNA-BASED COMPUTATION

**The Adleman
Hamiltonian Path
Experiment (1994)**

Seven Cities for a Hamiltonian Path Experiment



Routes for the Hamiltonian Path Experiment

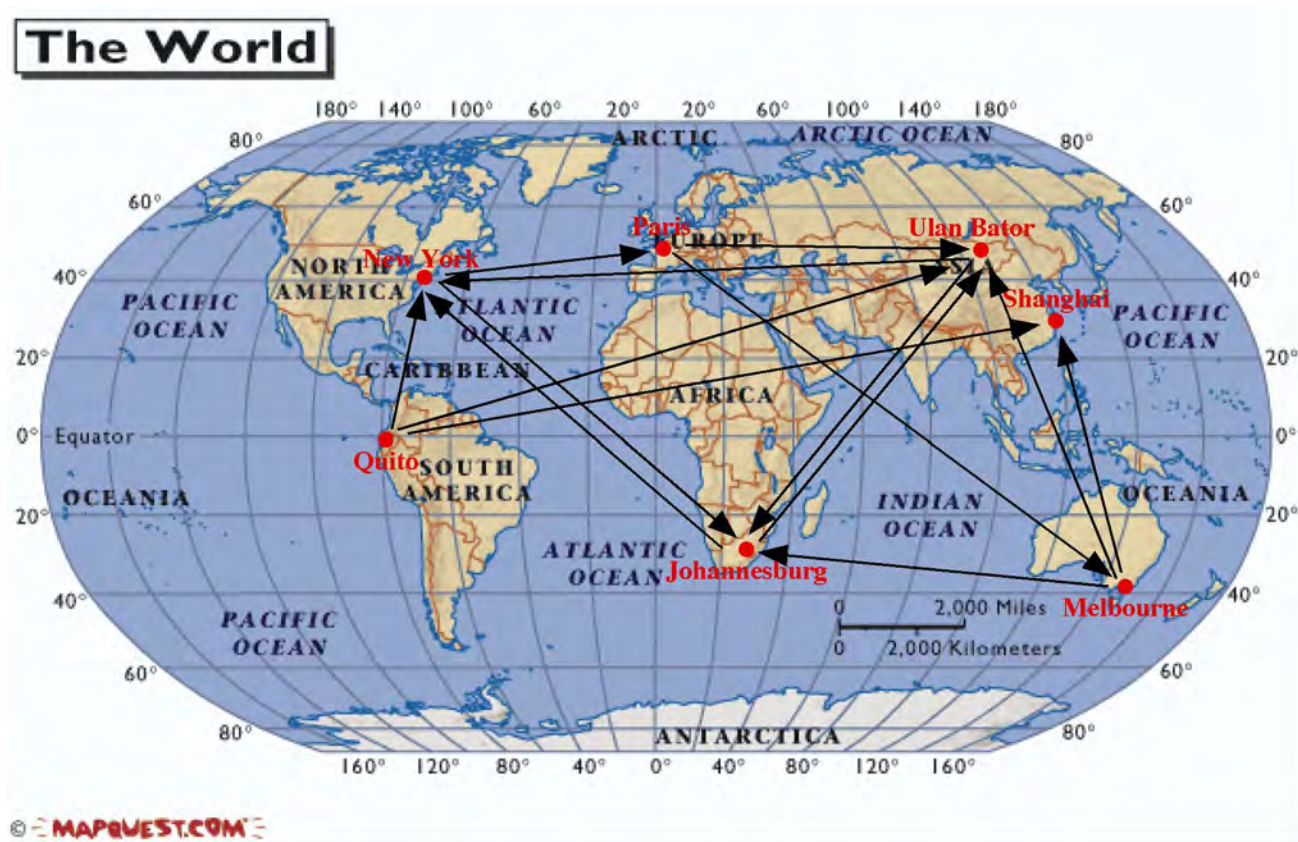

The Hamiltonian Path

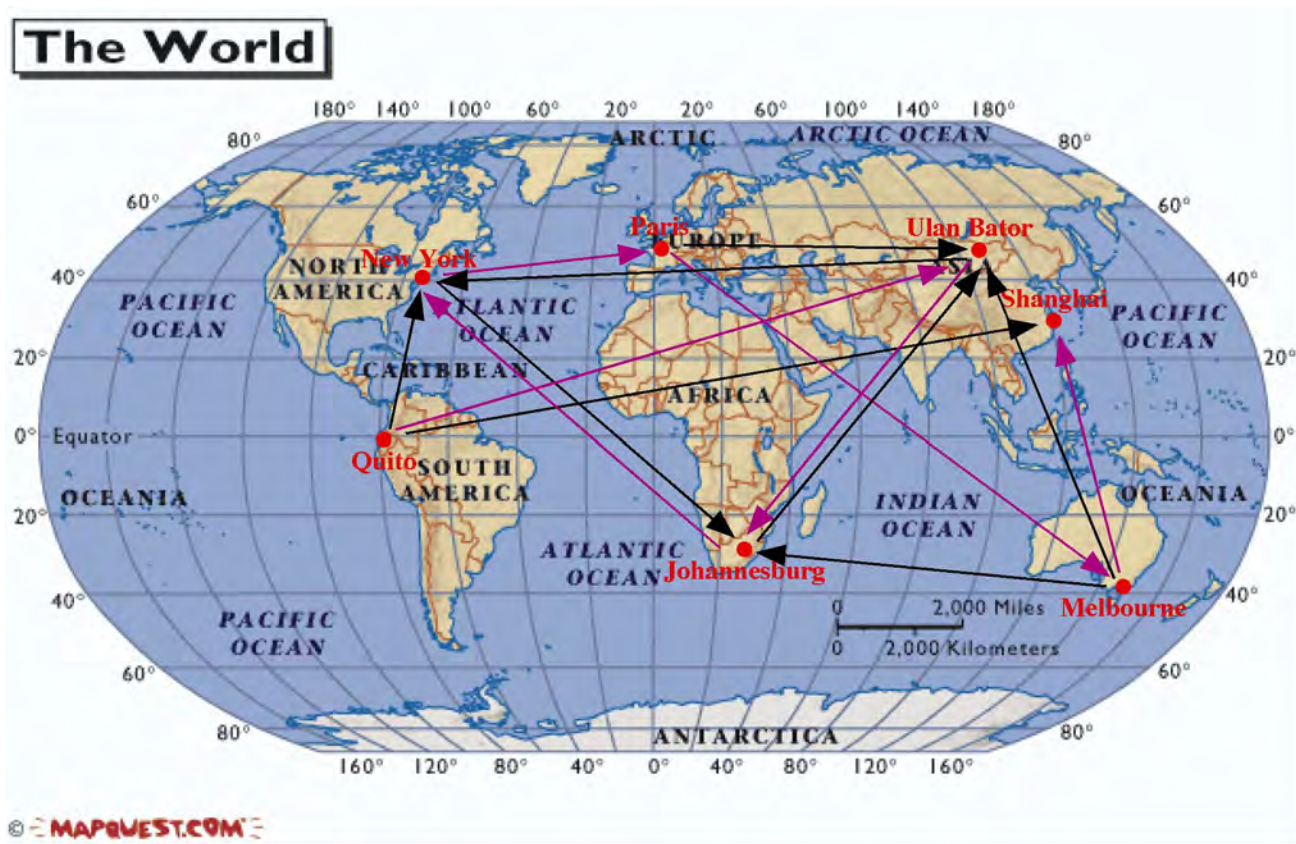

Assignment of Sequences

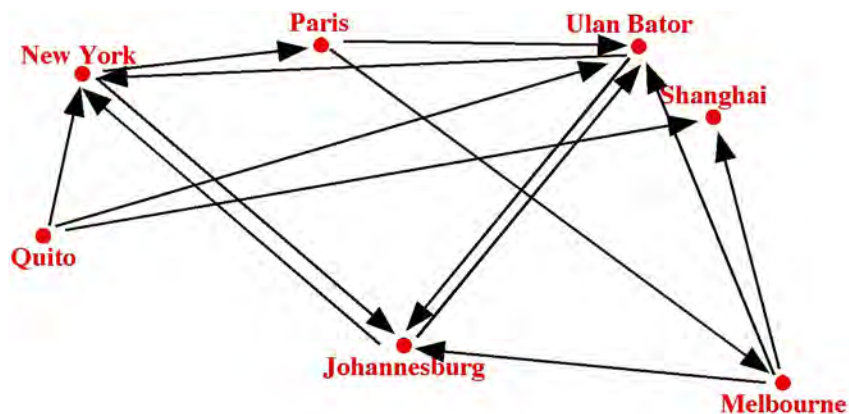

Represent Each City
as a 20-mer, with a
10-mer First Name
and a 10-mer Last Name

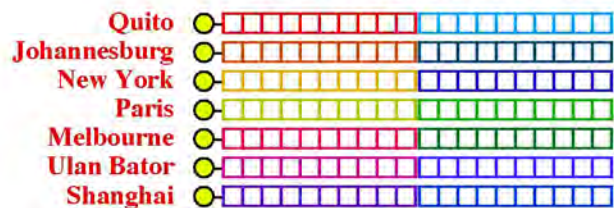

Represent Each Route
as the Complement to the
Last Name of Origin
and First Name of Destination

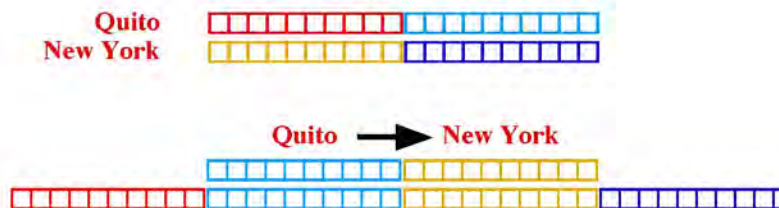

Strategy of the Hamiltonian Path Experiment

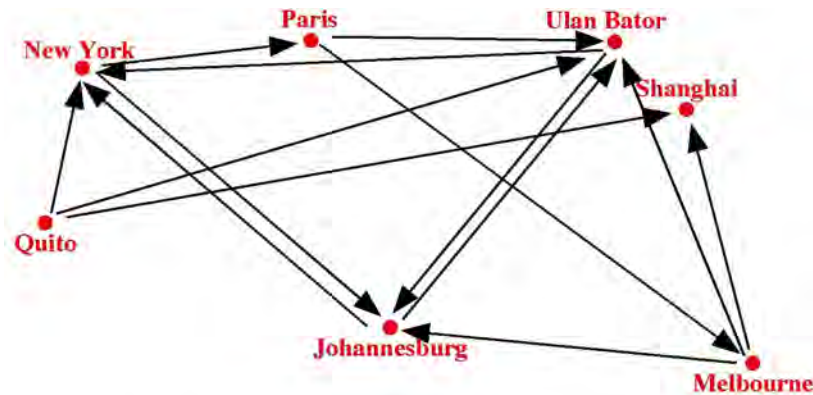

- [1] **Add All Cities (Phosphorylated) and All Routes (as Catalysts) to the Solution and Ligate.**
- [2] **Targets are all 140-mers, so Run the Products on a Gel and Select 140-mers.**
- [3] **To Select Routes that Start in Quito and End in Shanghai, Run PCR with Primers Complementary Quito and Shanghai.**
- [4] **Demonstrate All Intermediate Cities by Selecting for Each of Their Complements on Magnetic Beads.**

Algorithmic Assembly: A Cumulative XOR Calculation

Chengde Mao
Thom LaBean (Duke)
John Reif (Duke)

Wang Tiles

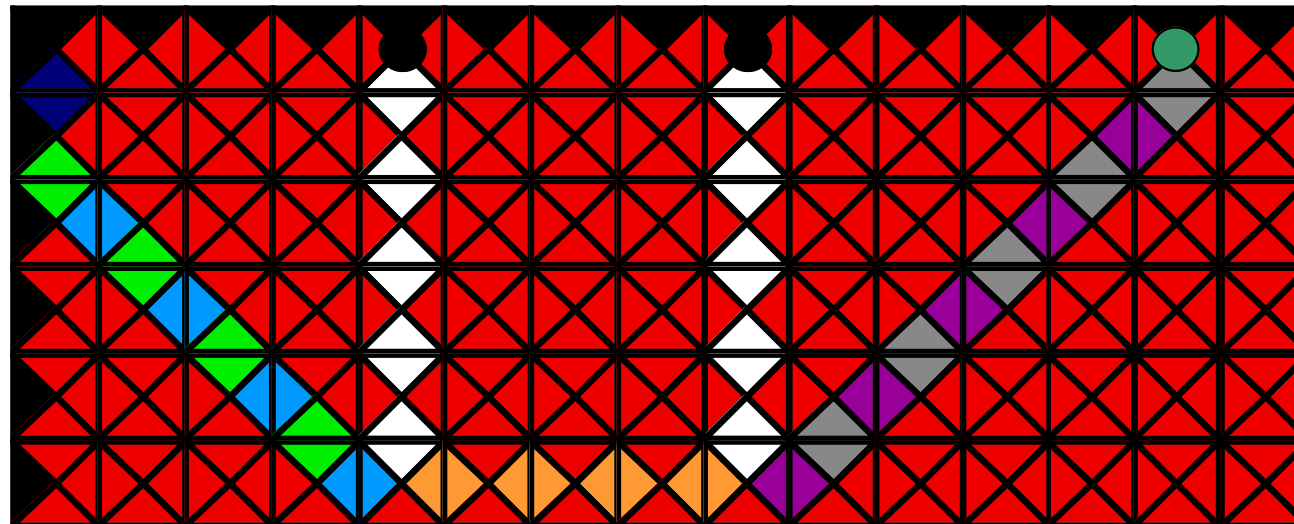
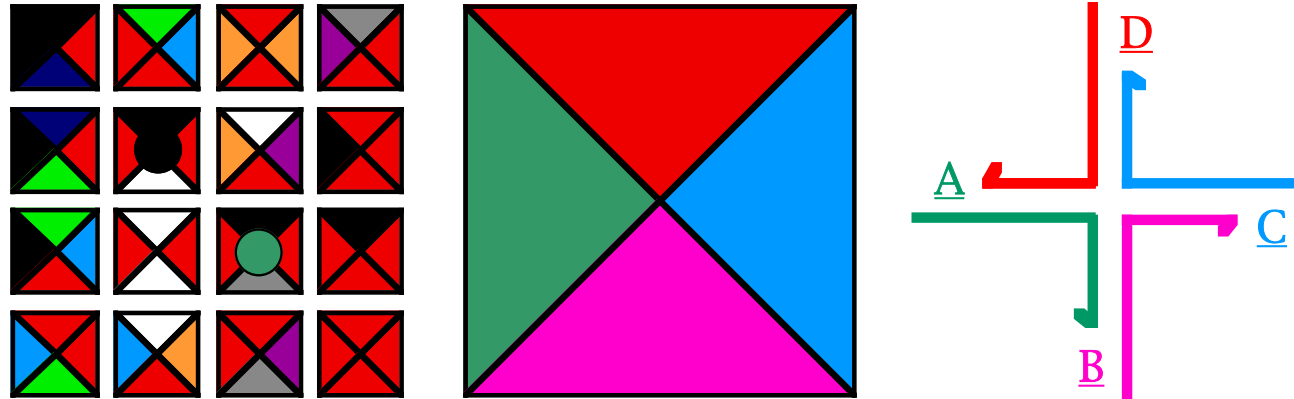

The *XOR* Operation

A	B	A <i>XOR</i> B
0	0	0
0	1	1
1	0	1
1	1	0

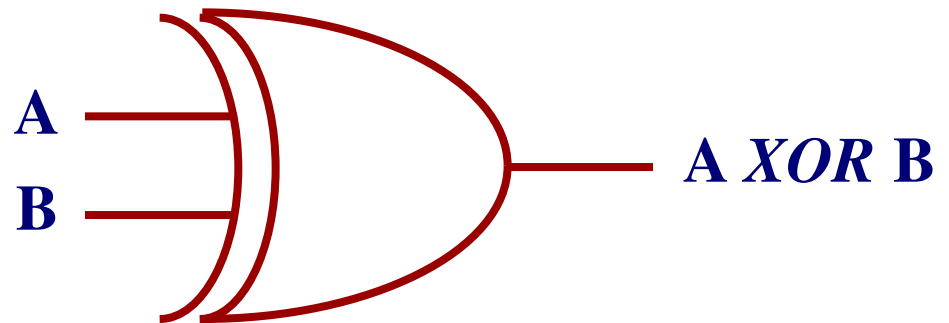

Cumulative *XOR*

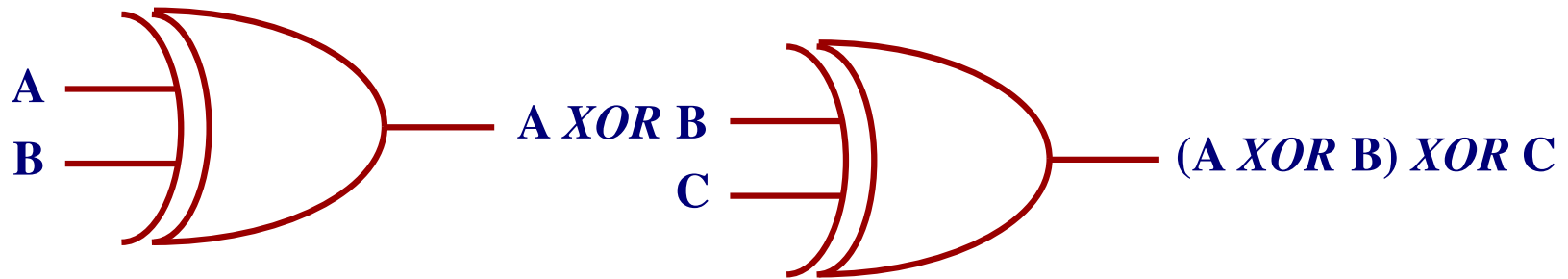

A Cumulative XOR Calculation: Tiles

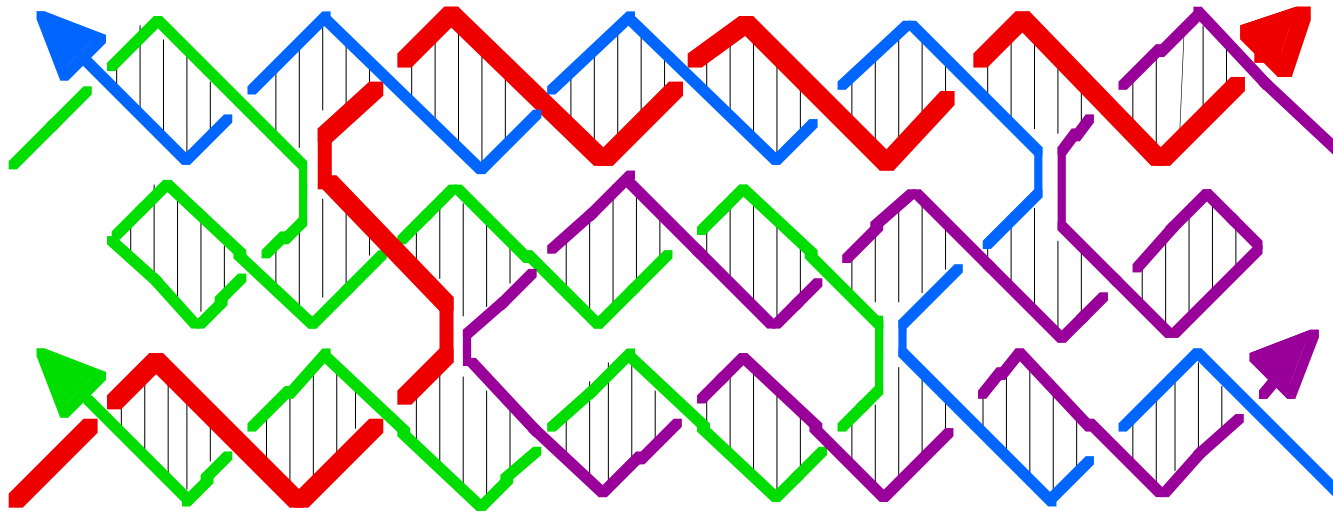

Schematic of a Lattice Containing 3 DX Tiles and 1 DX+J Tile

**Correct Tiles Compete
Against Incorrect Tiles**

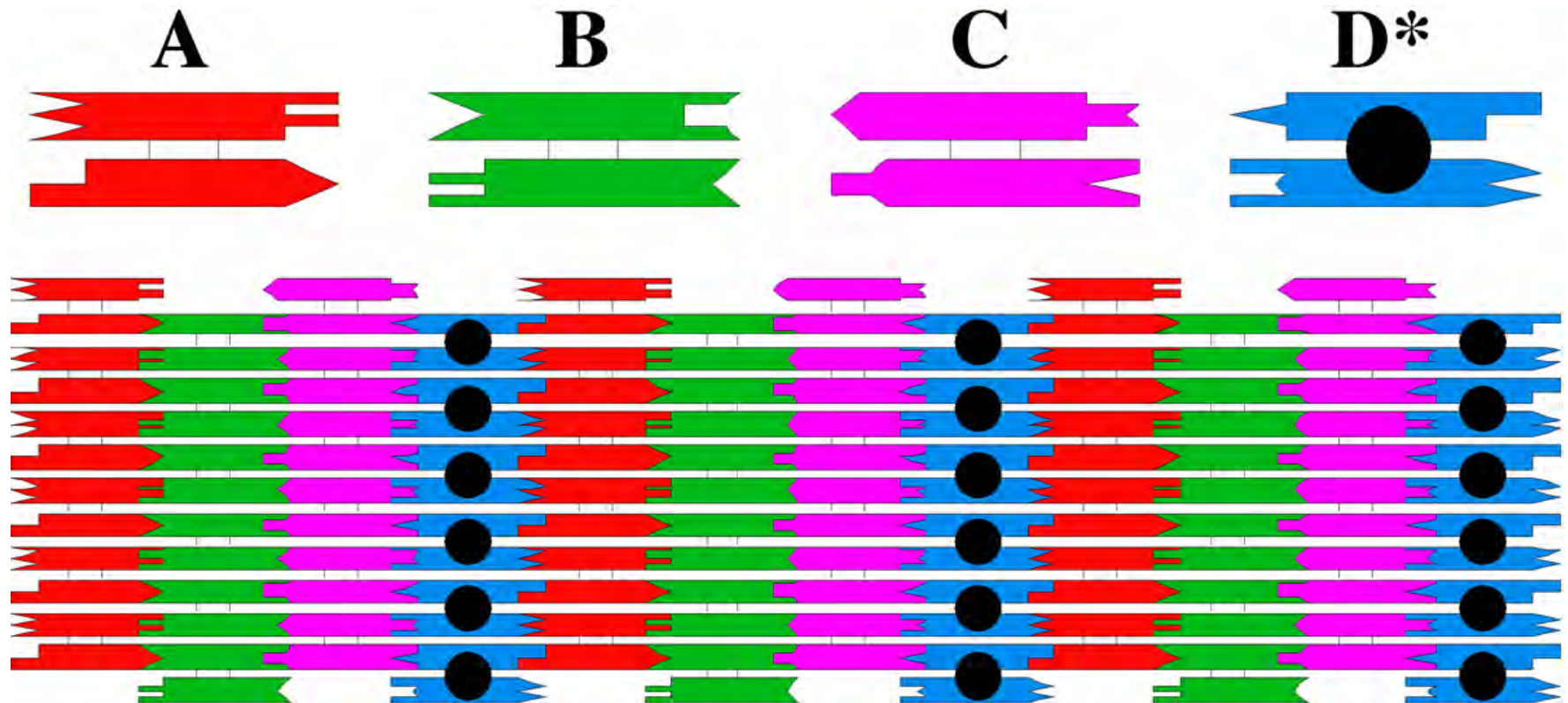

Tiles for the Cumulative XOR Calculation

Correct Tiles Compete Against Half-Correct Tiles

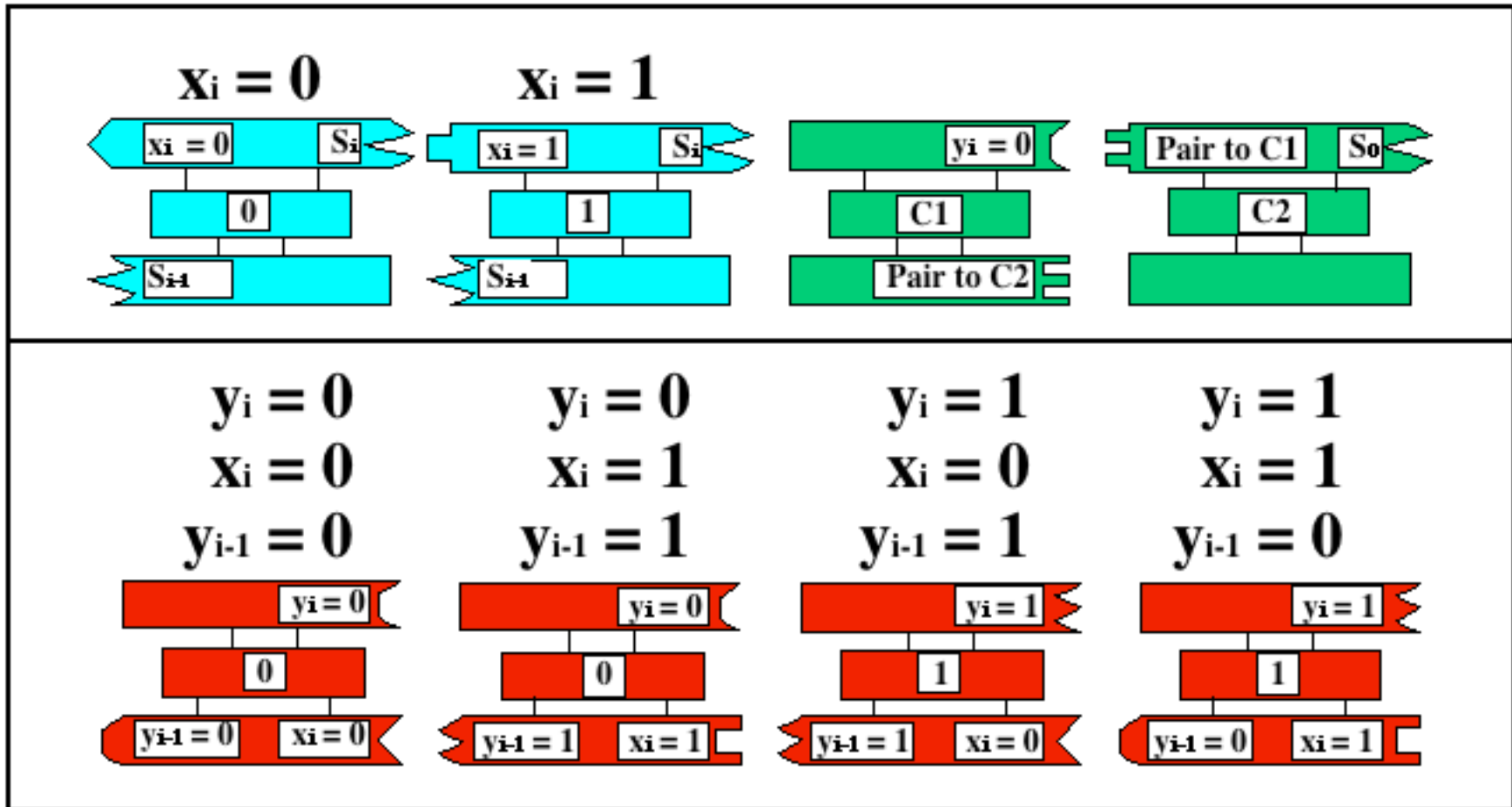

A Cumulative XOR Calculation: Assembly

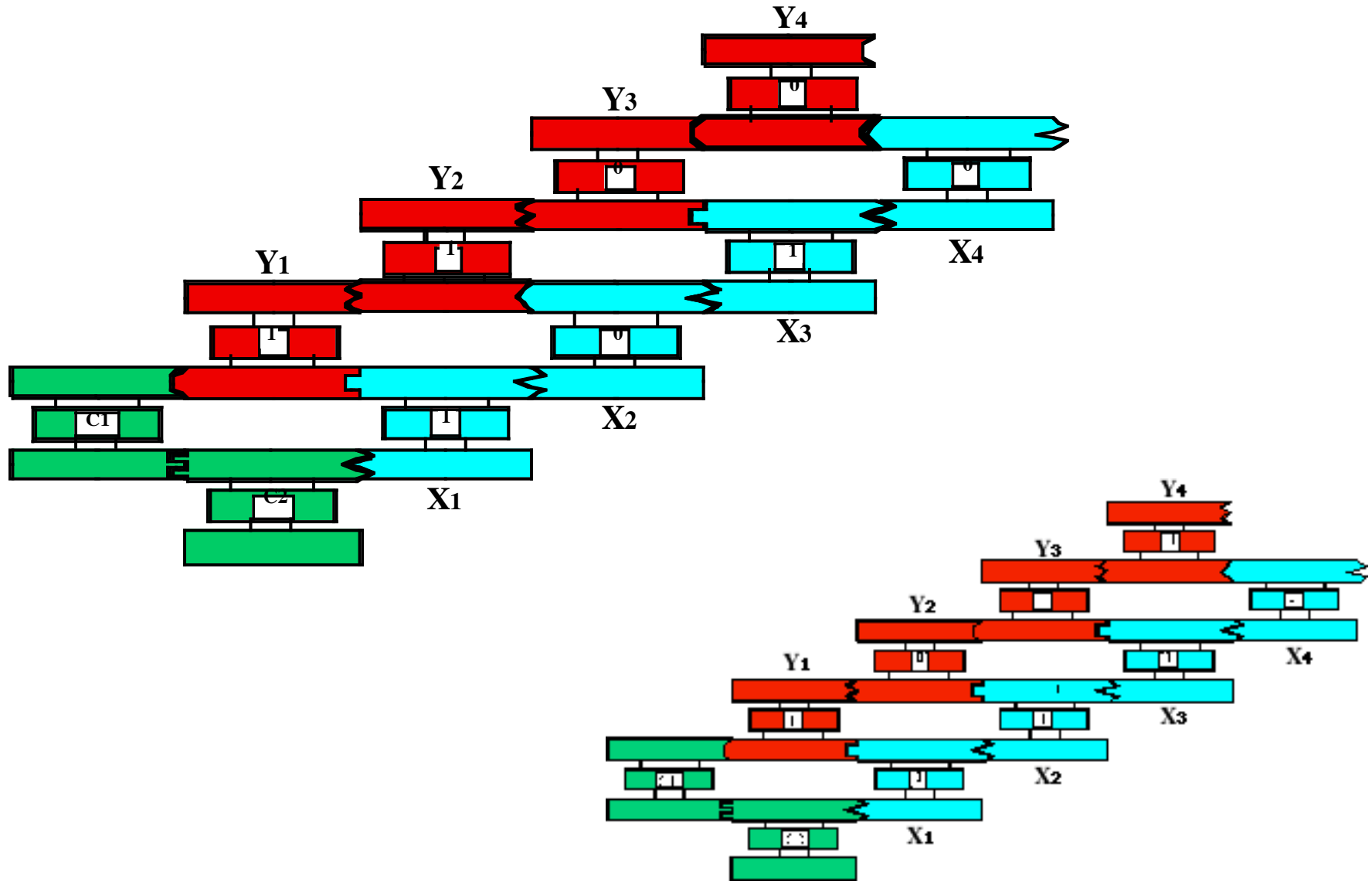

A Cumulative XOR Calculation: Extracting the Answer

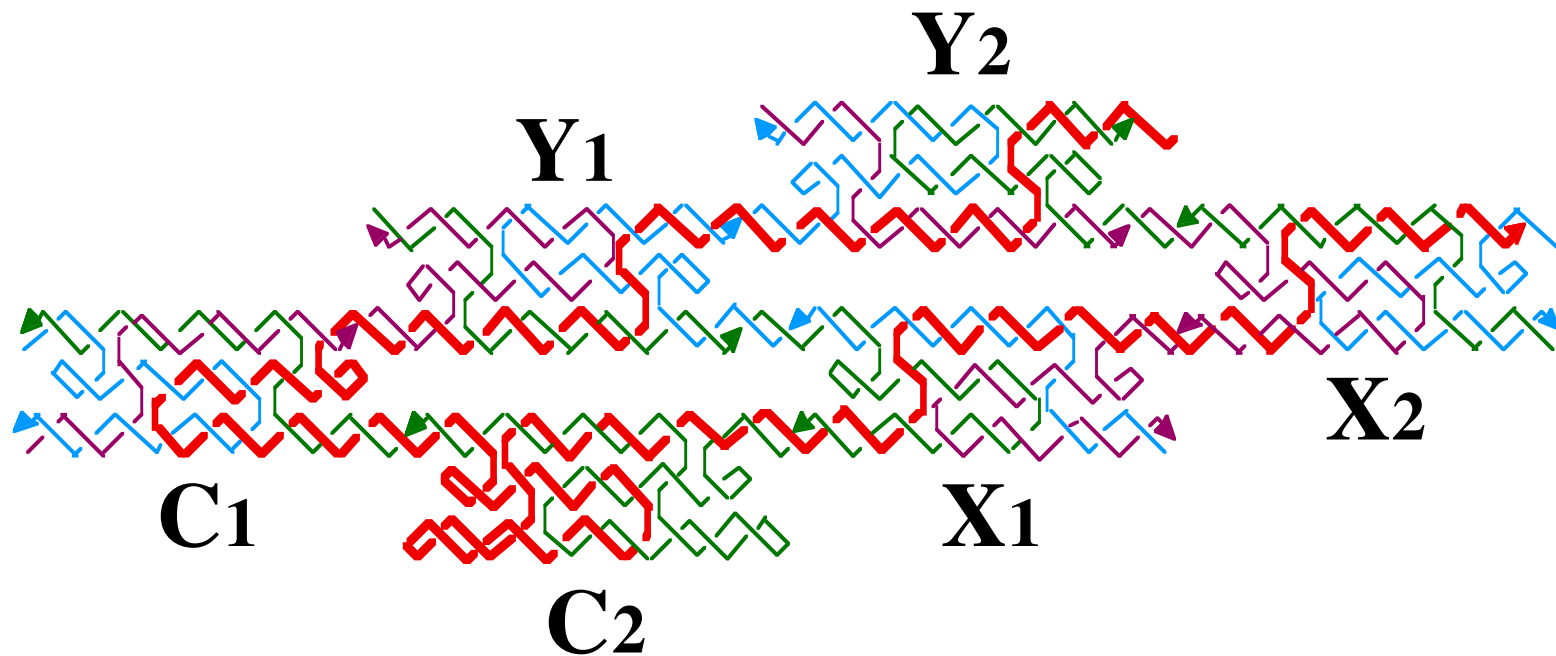

A Cumulative XOR Calculation: Data

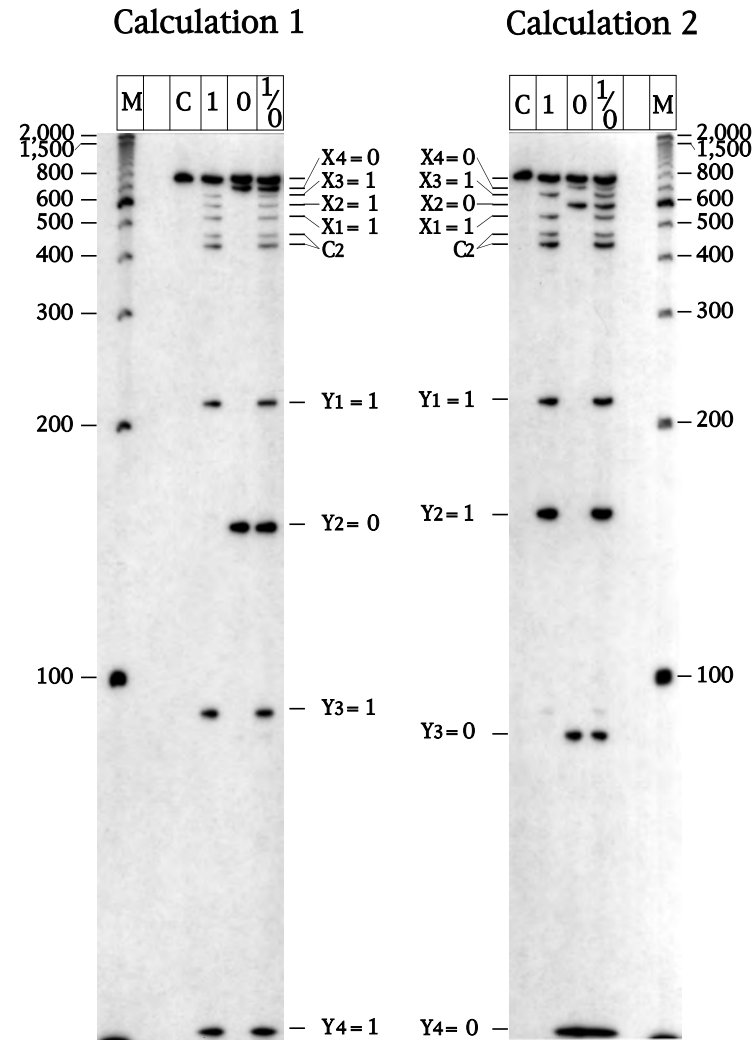

**2D Algorithmic
Assembly: A
Sierpinski Triangle by
Paul Rothemund,
Nick Papadakis &
Erik Winfree**

The Sierpinski Triangle is Pascal's Triangle, Mod 2

It can be Generated by XOR in 2 Dimensions

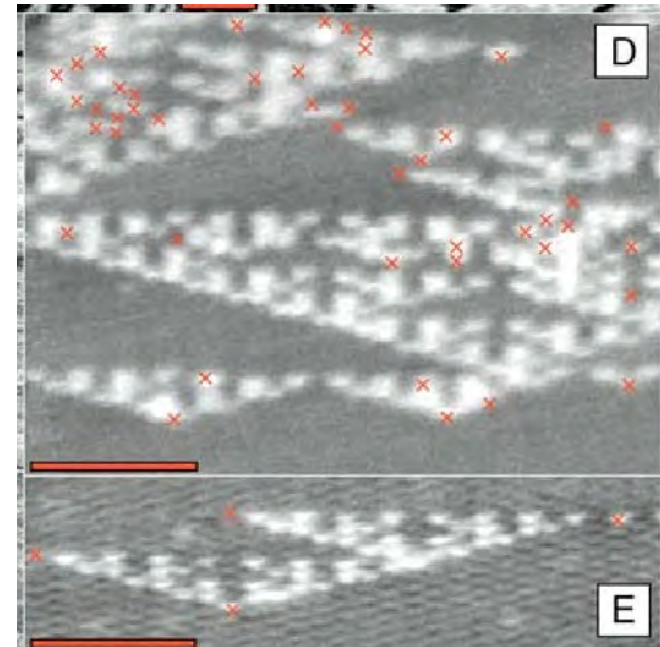
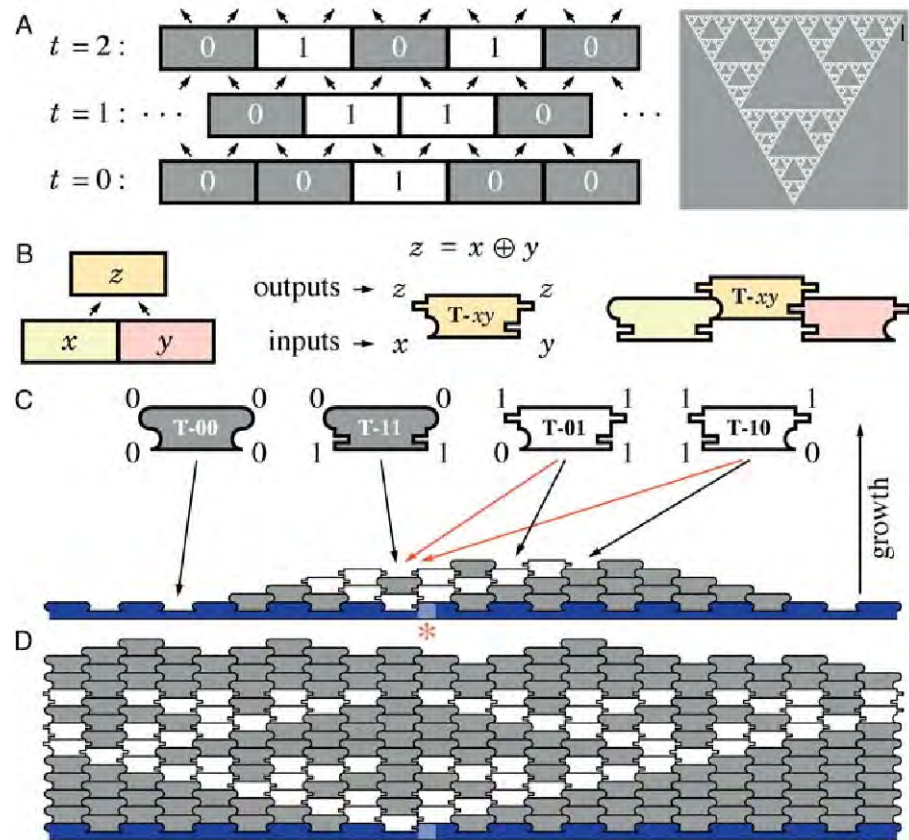

**Pairs of Inserted
PX-JX₂ Devices Used
to Program a Pattern**

**Hongzhou Gu
Jie Chao**

Programming an Array for Assembly

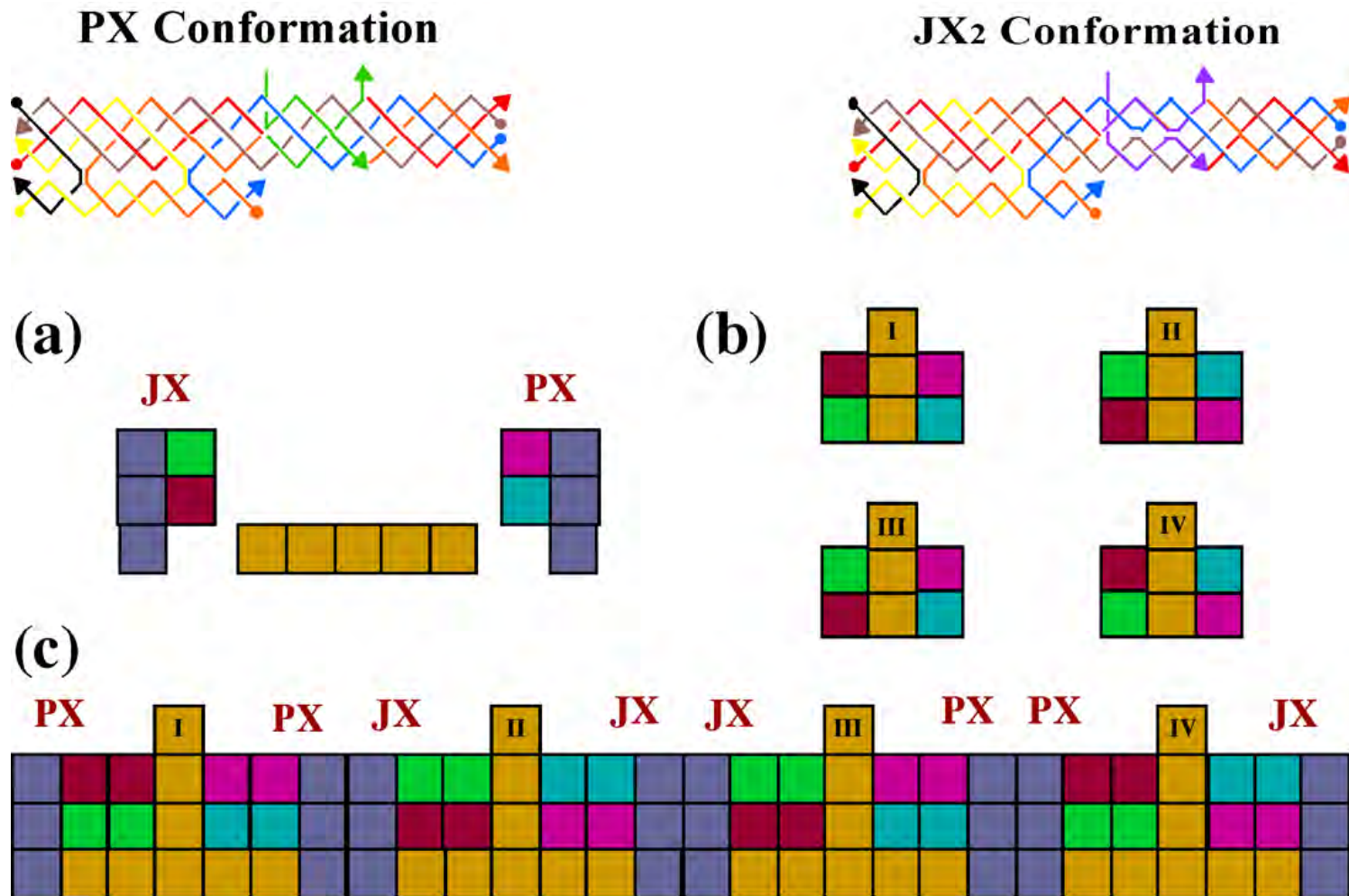

Producing Patterns from Long Viral Strands

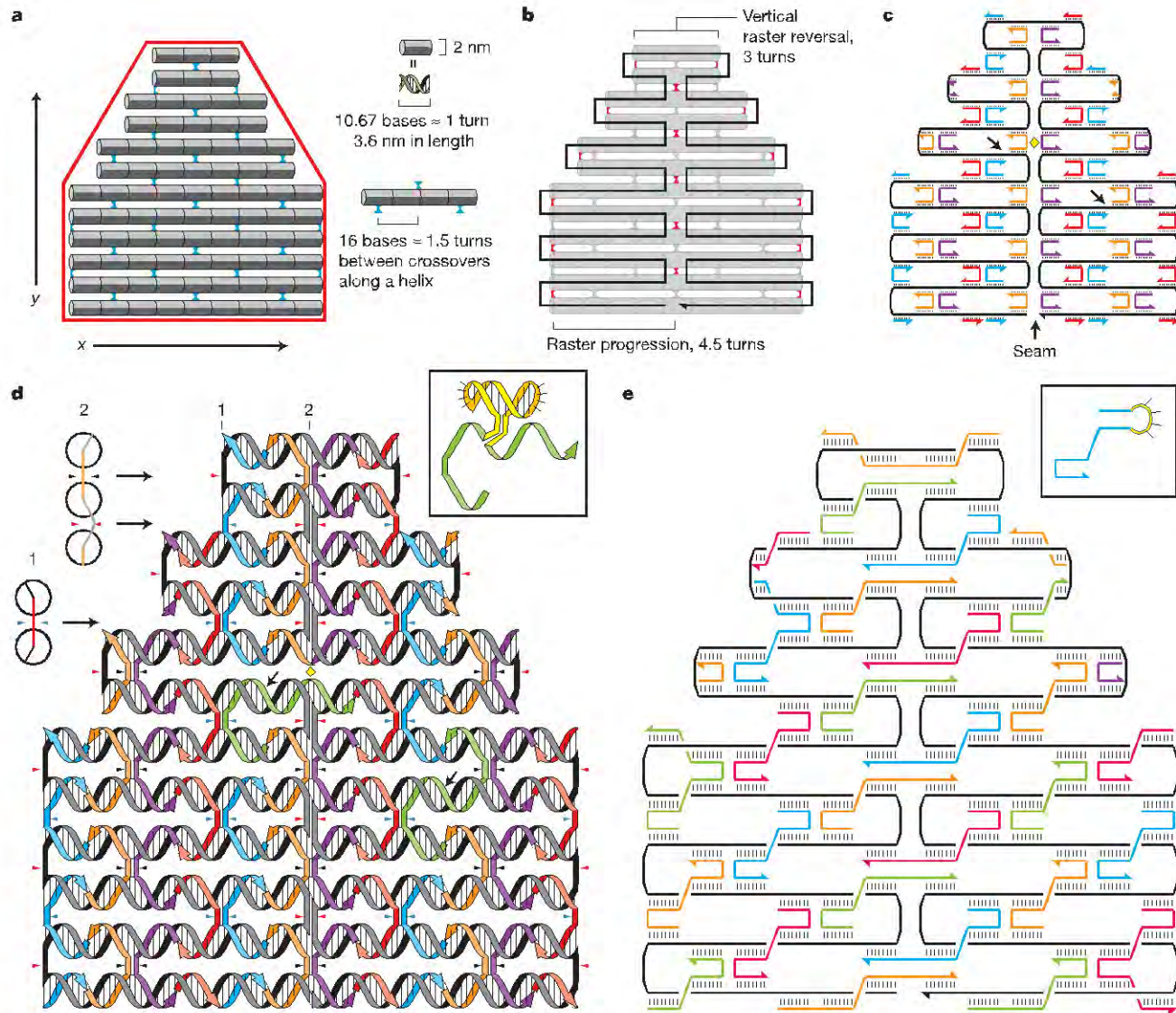

Various Shapes from Long Viral Strands

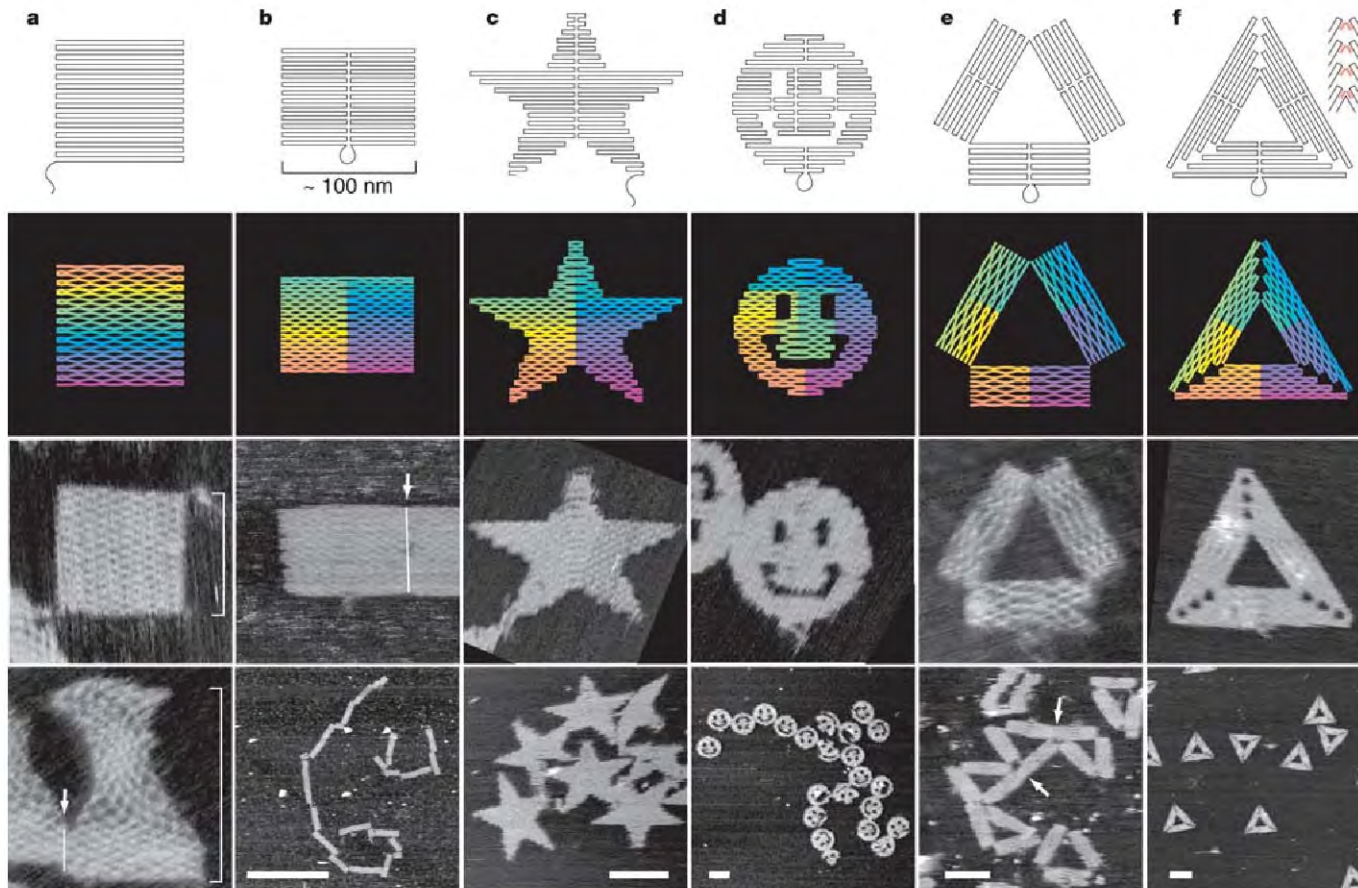

AFM Image of Blank Origami Arrays for Insertion

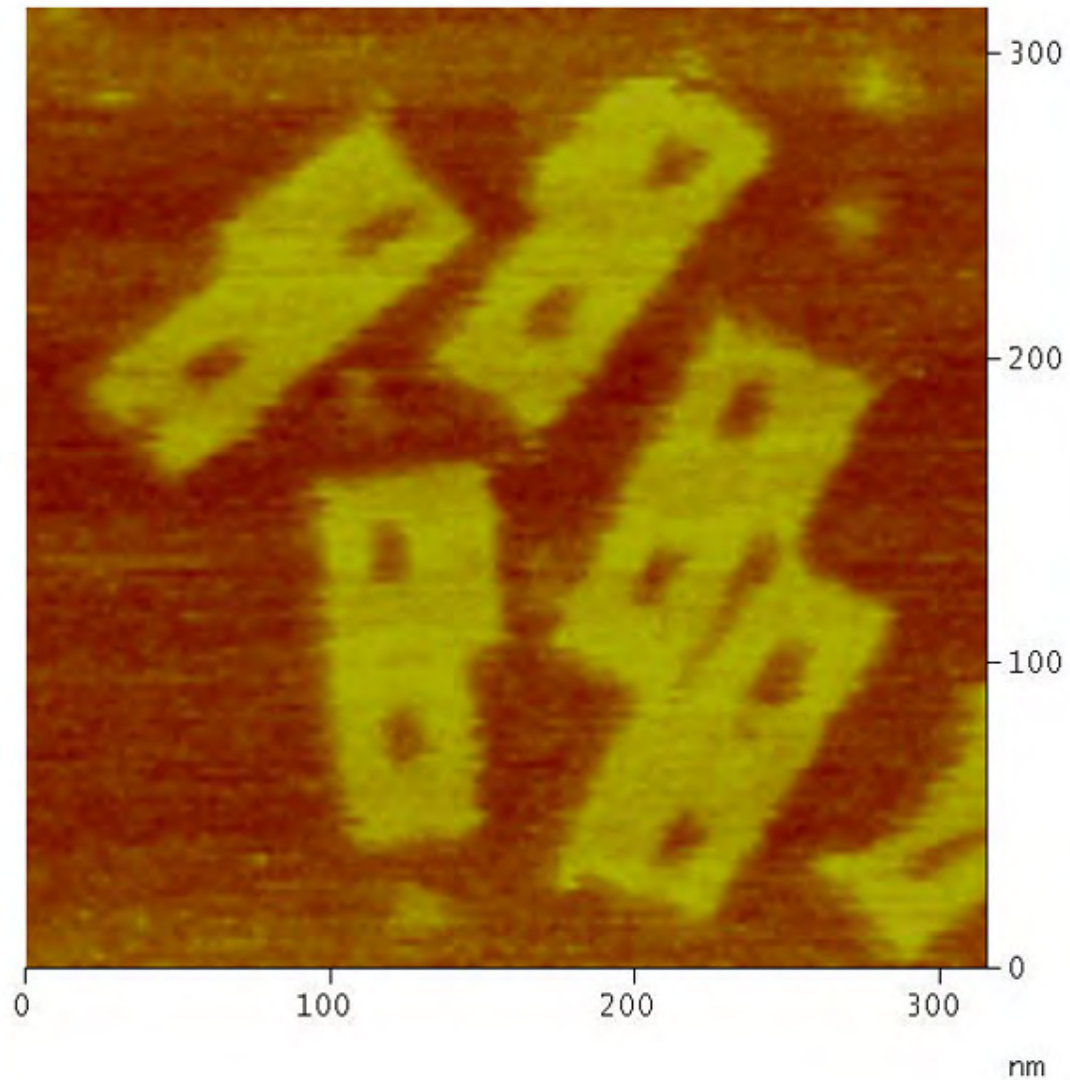

H. Gu, J. Chao, S-J. Xiao & N.C. Seeman, *Nature Nanotech.* **4**, 245-249 (2009).

AFM Image of Origami Arrays with Inserted Cassettes

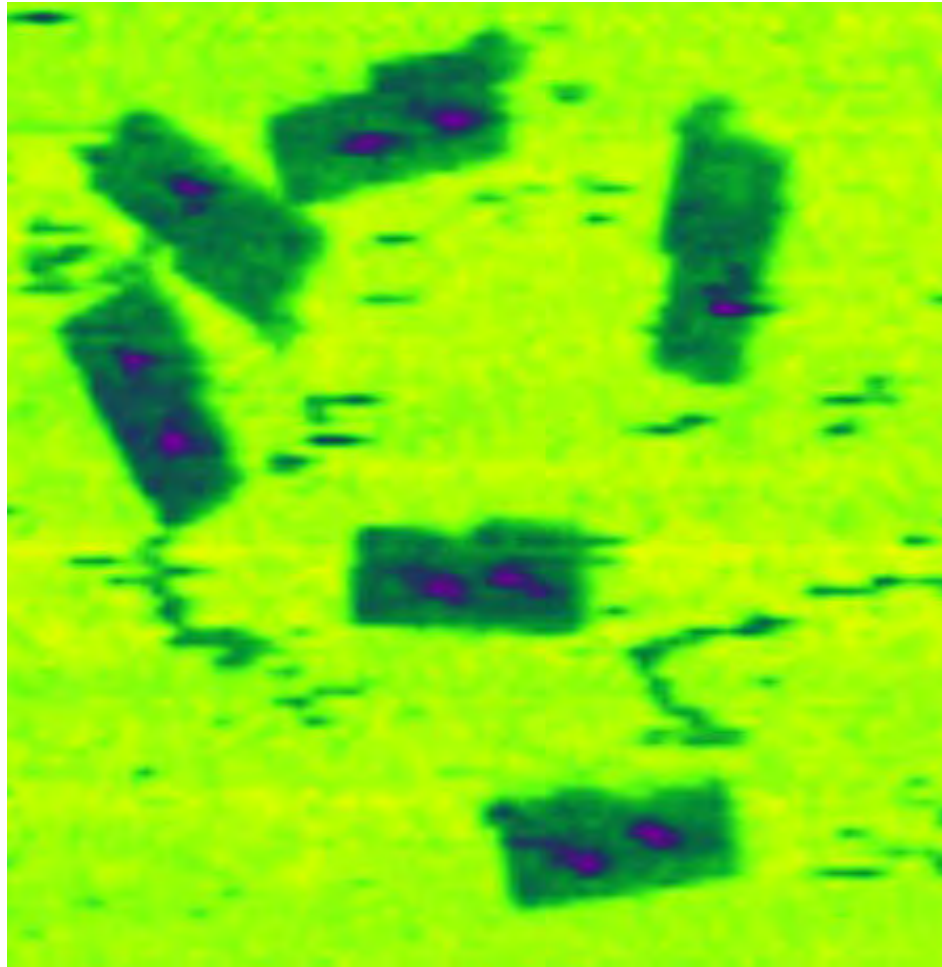

Schematics of Programmed Patterns Made By Capturing Different Molecules

JX-JX

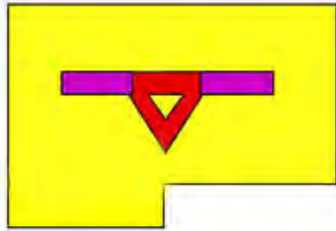

JX-PX

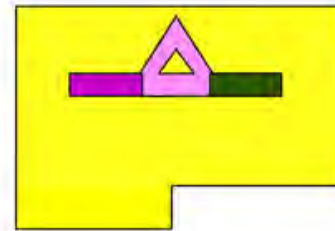

PX-JX

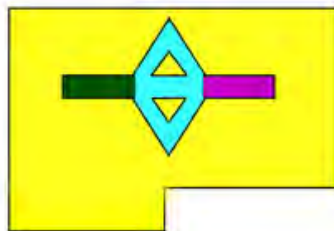

PX-PX

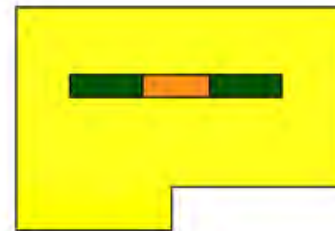

AFM Images of JX-JX Patterns

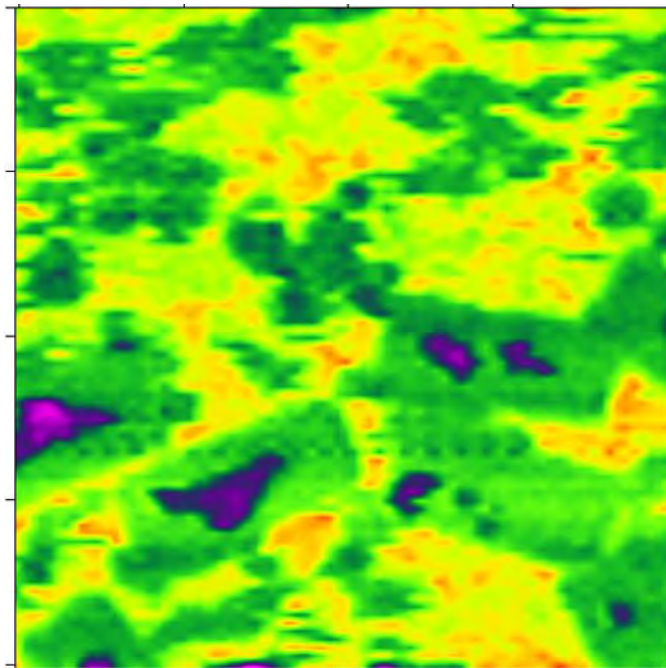
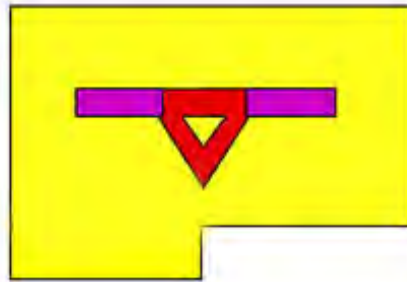

AFM Images of JX-PX Patterns

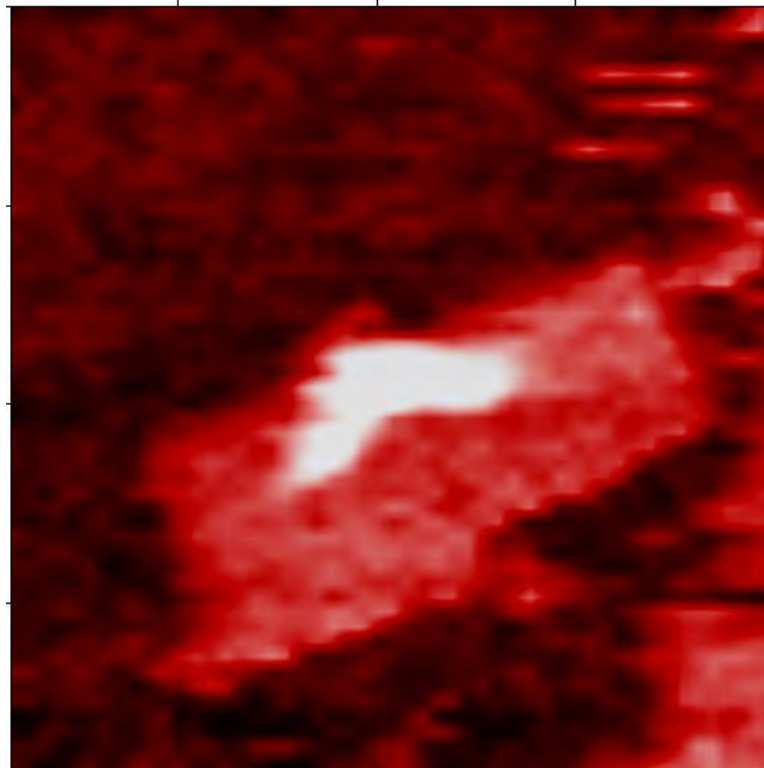
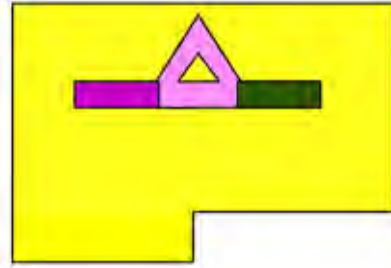

AFM Images of PX-JX Patterns

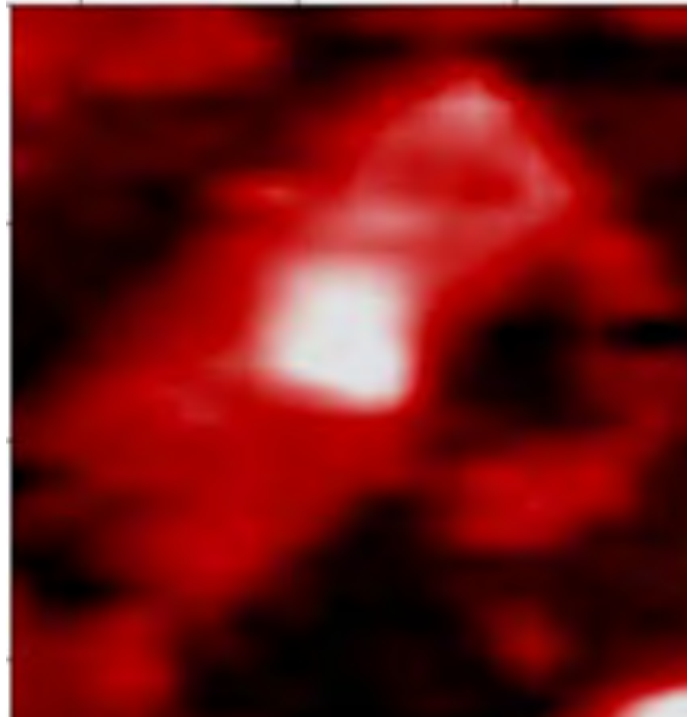
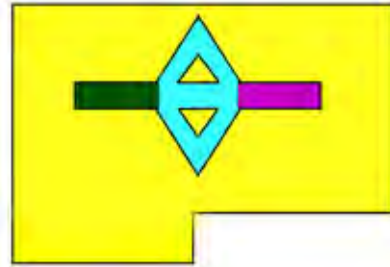

AFM Images of PX-PX Patterns

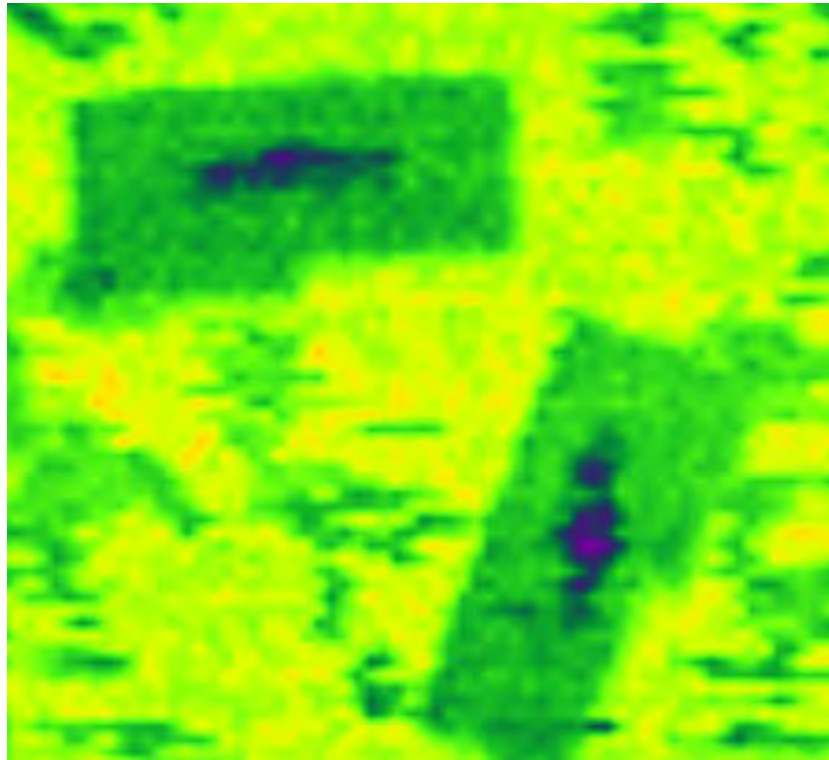
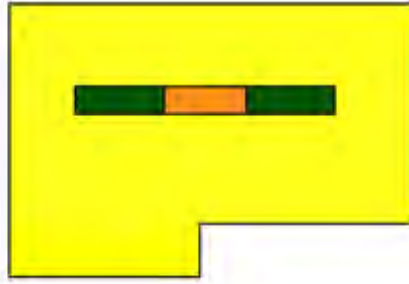

Error-Free Binding Protocol

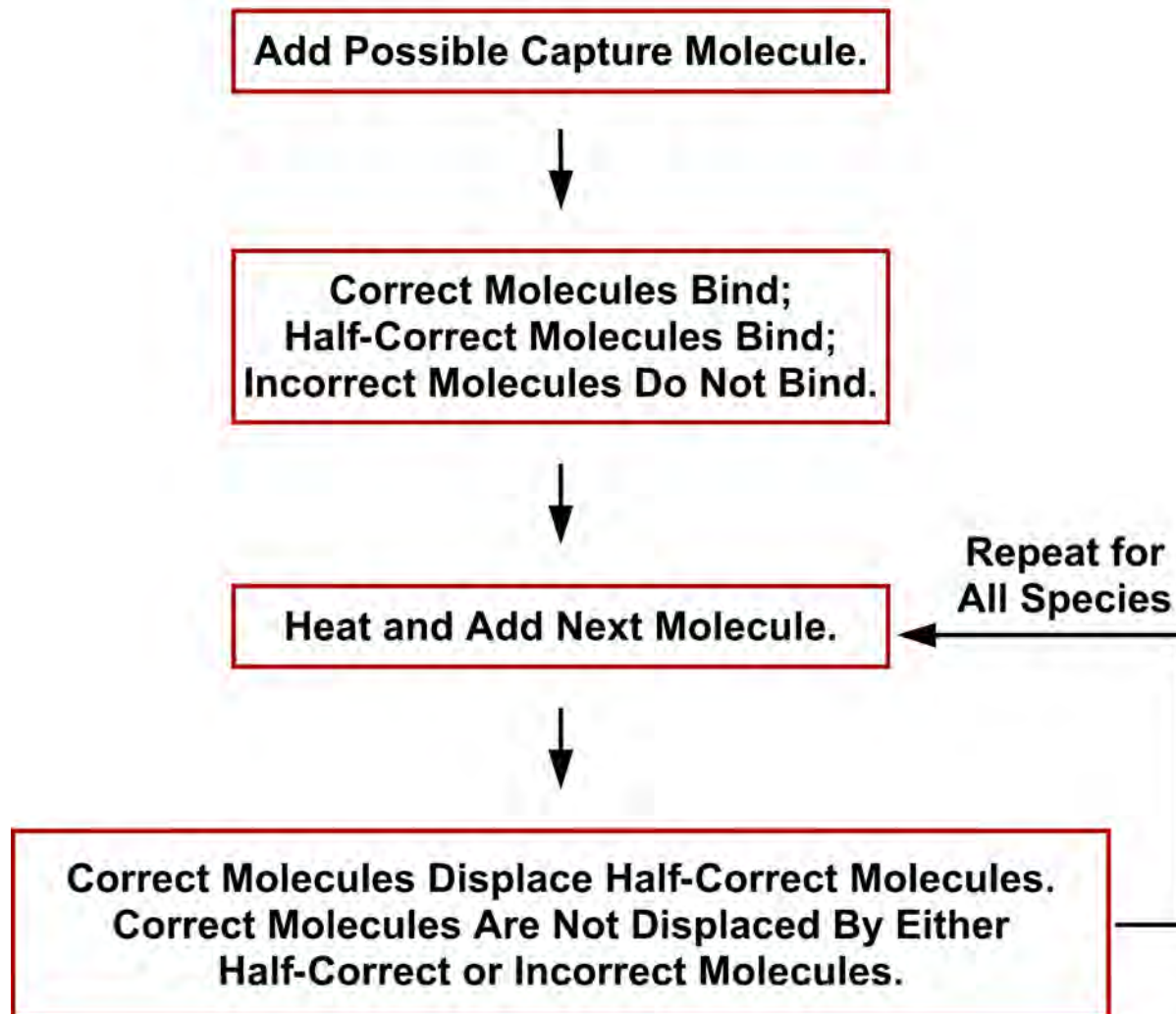

DNA SELF-ASSEMBLY AS COMPUTATION

**Assembly of a DNA Nano-Object Solves a
Graph Theory Problem**

Gang Wu

Natasha Jonoska (U. South Florida)

System to Determine Graph 3-Colorability

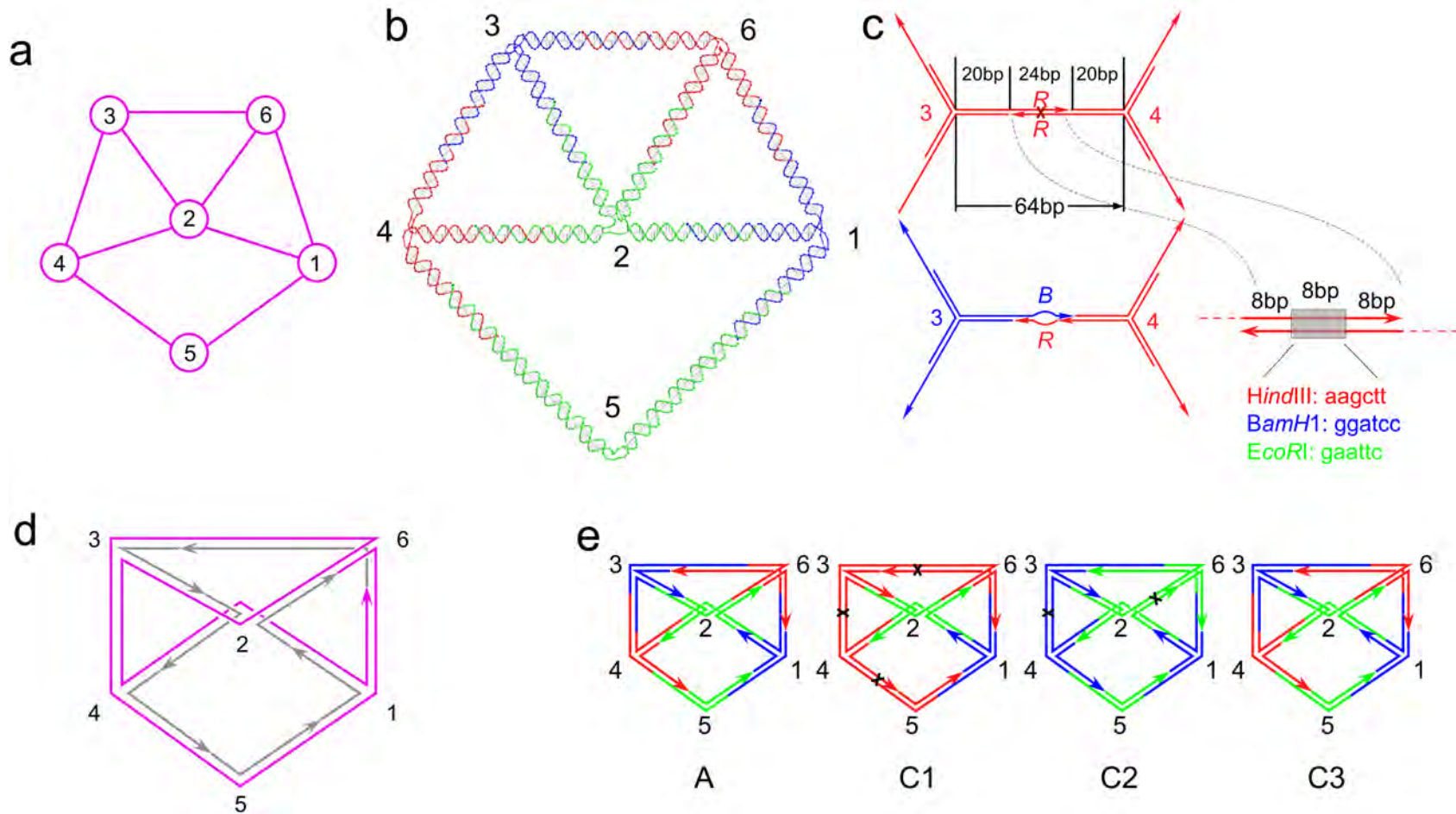

Result of 3-Colorability Experiments

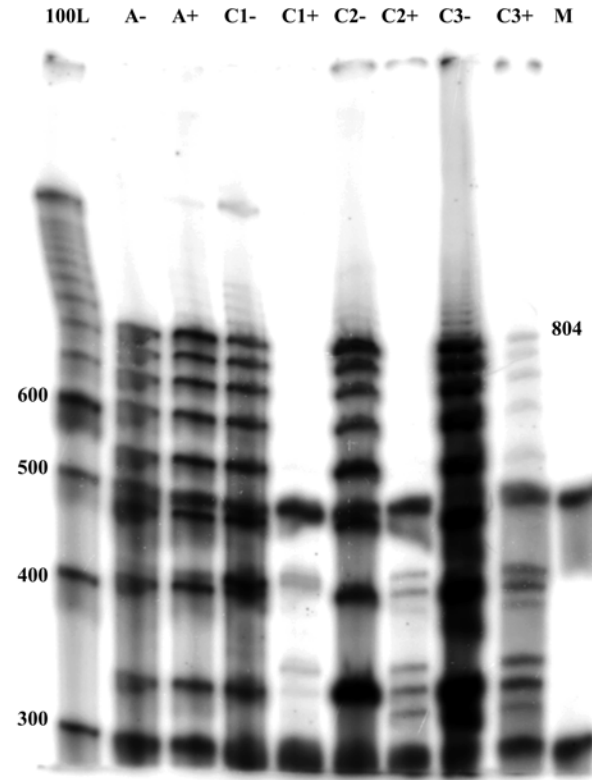
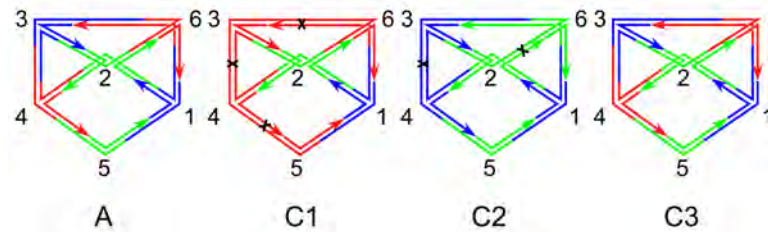

DNA Nanotechnology:

**Combining Multiple
Components**

Combining Multiple Components: The Macroscopic Scale

Self-Opening Umbrella

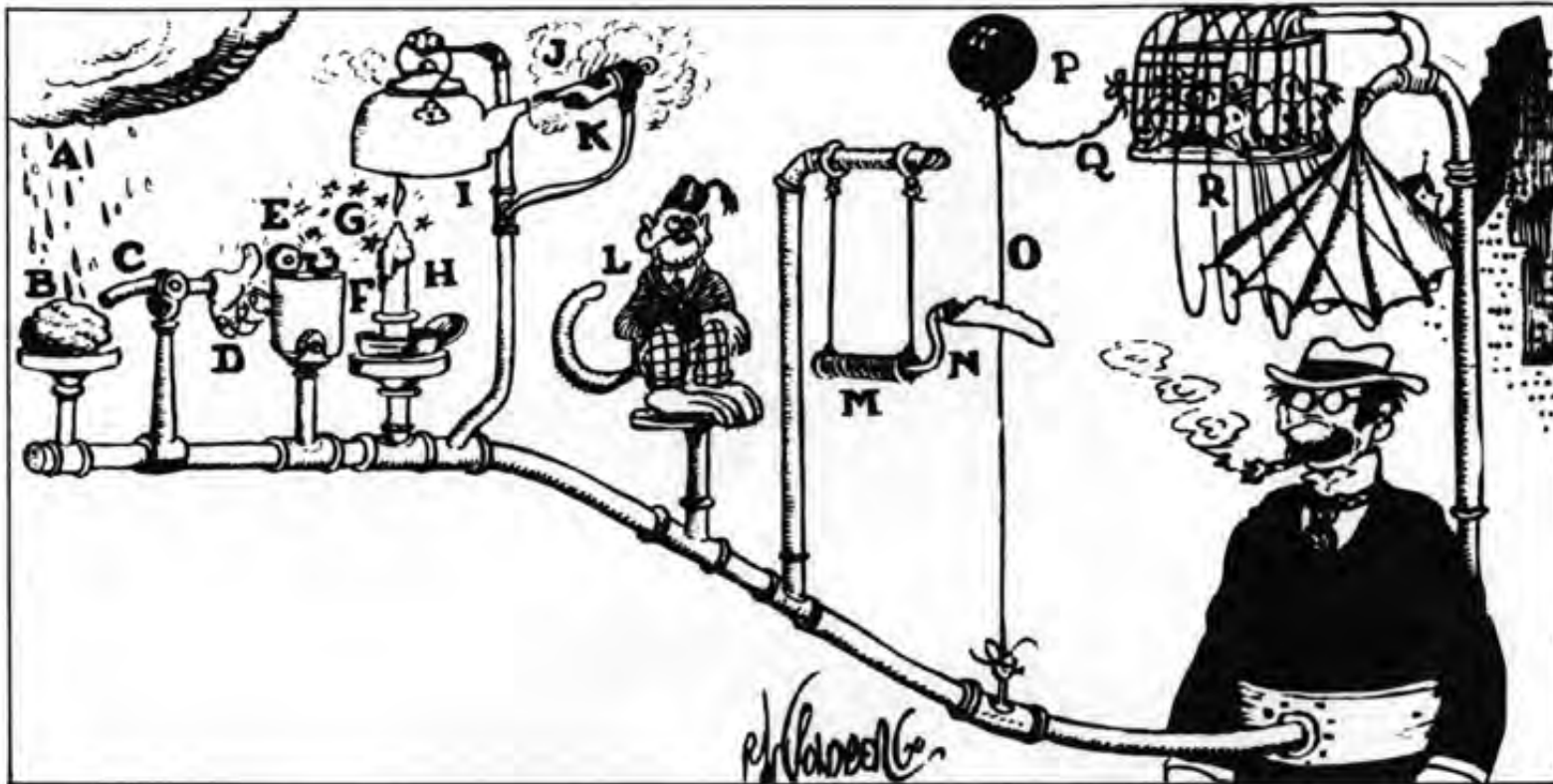

**A Proximity-Based
Programmable
Nanoscale
Assembly Line**

**Hongzhou Gu
Jie Chao**

Combining Components

PX-JX₂ Cassettes

Clocked Walker

Nanoparticles

DNA Origami

Automobile Assembly Line (1920s)

Framework

**Directable
Assembler**

Conveyor

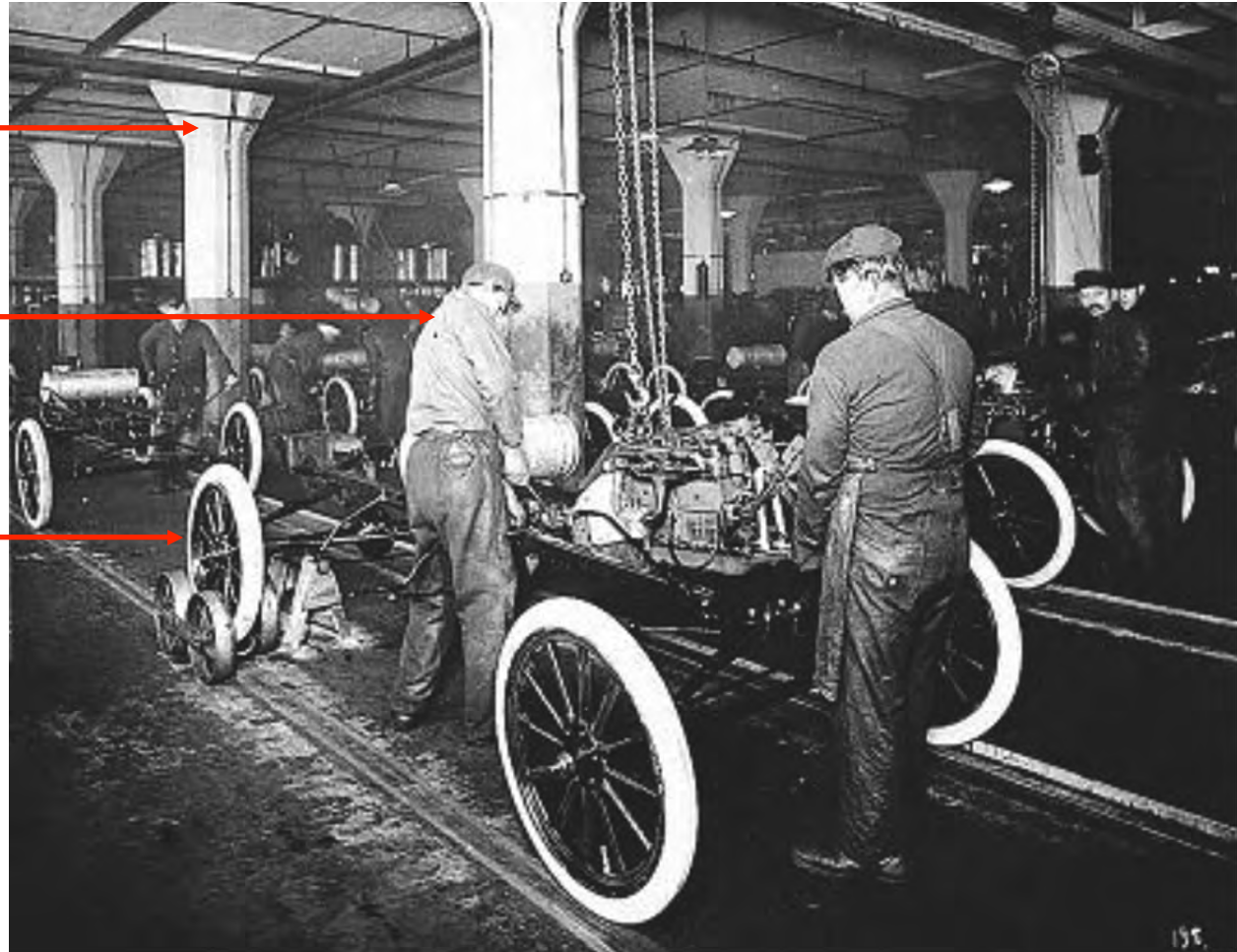

Requirements for this System

- [1] **Directable Assembler** <--> **PX-JX₂ Cassette**
- [2] **Inter-Station Conveyer** <--> **Trigonal Walker**
- [3] **Framework for the System** <--> **DNA Origami**

Mechanism of Assembly

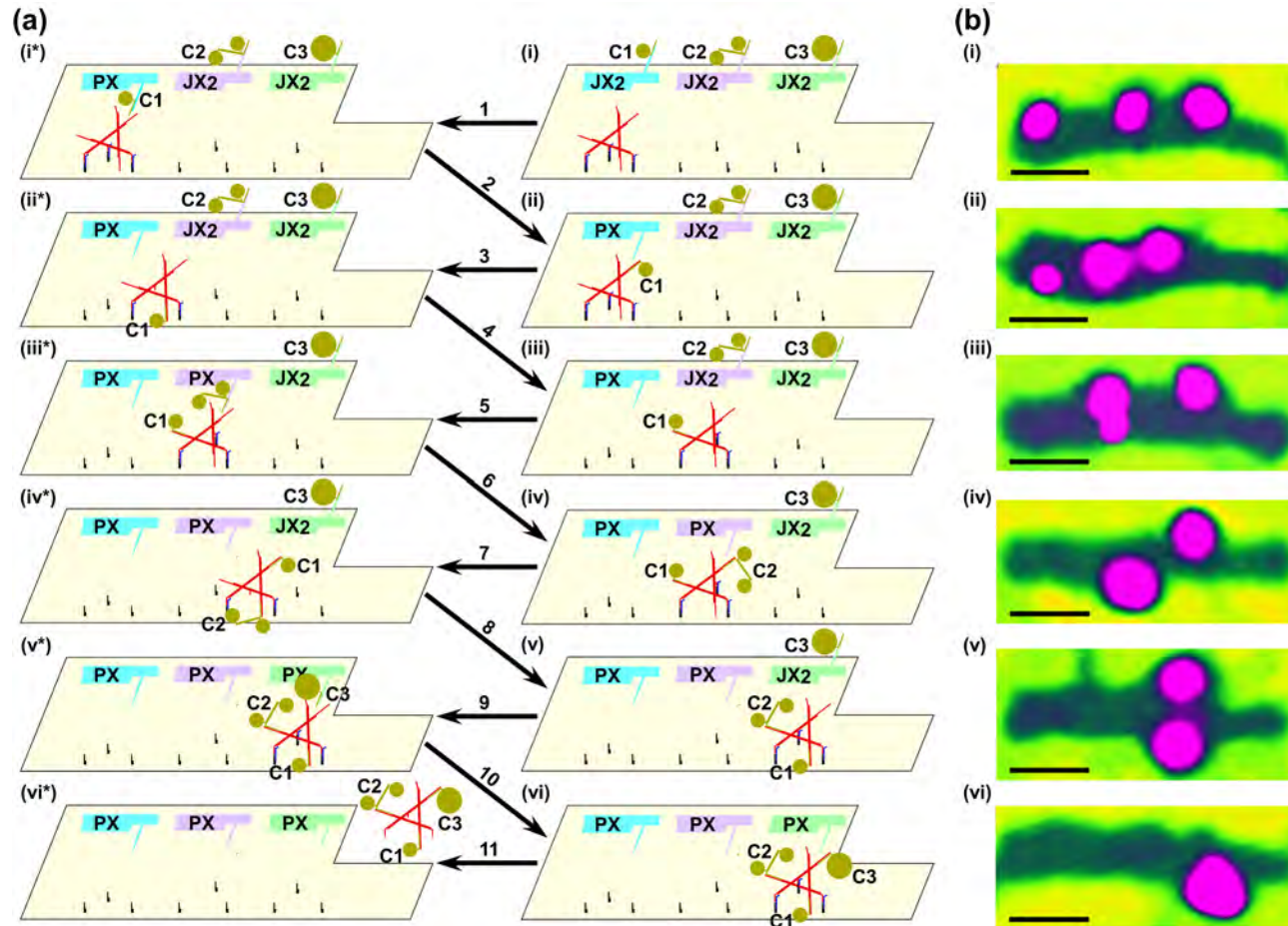

Walker Structure

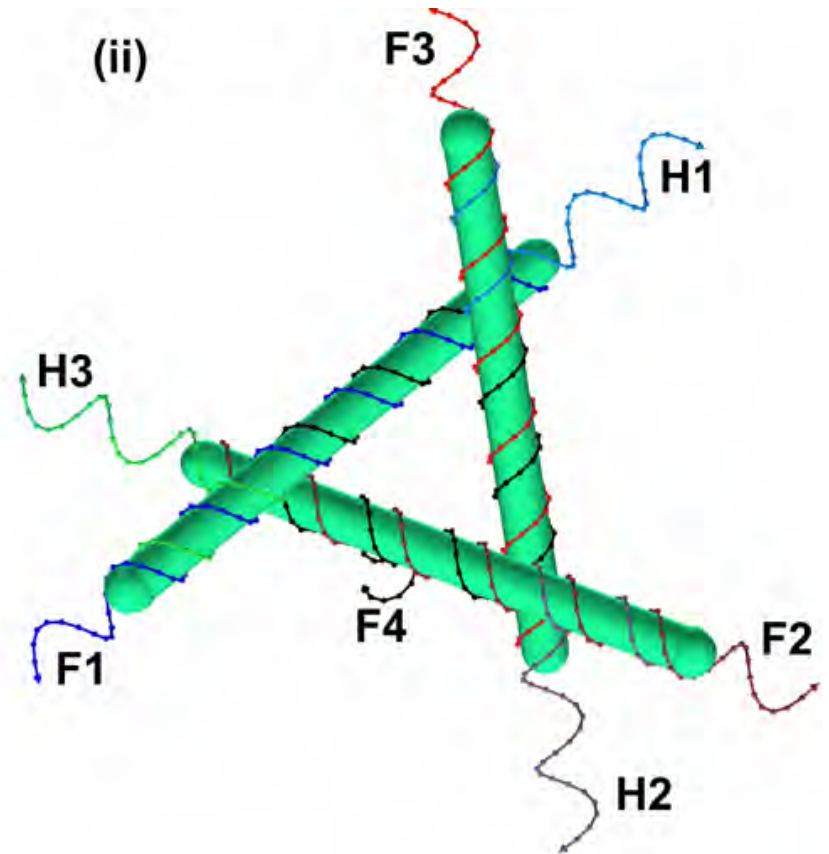
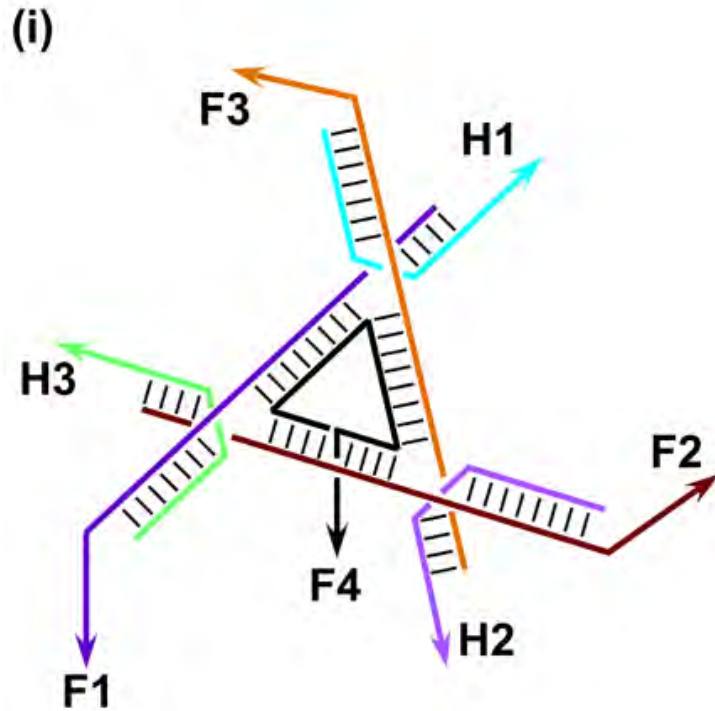

Cargo Transfer

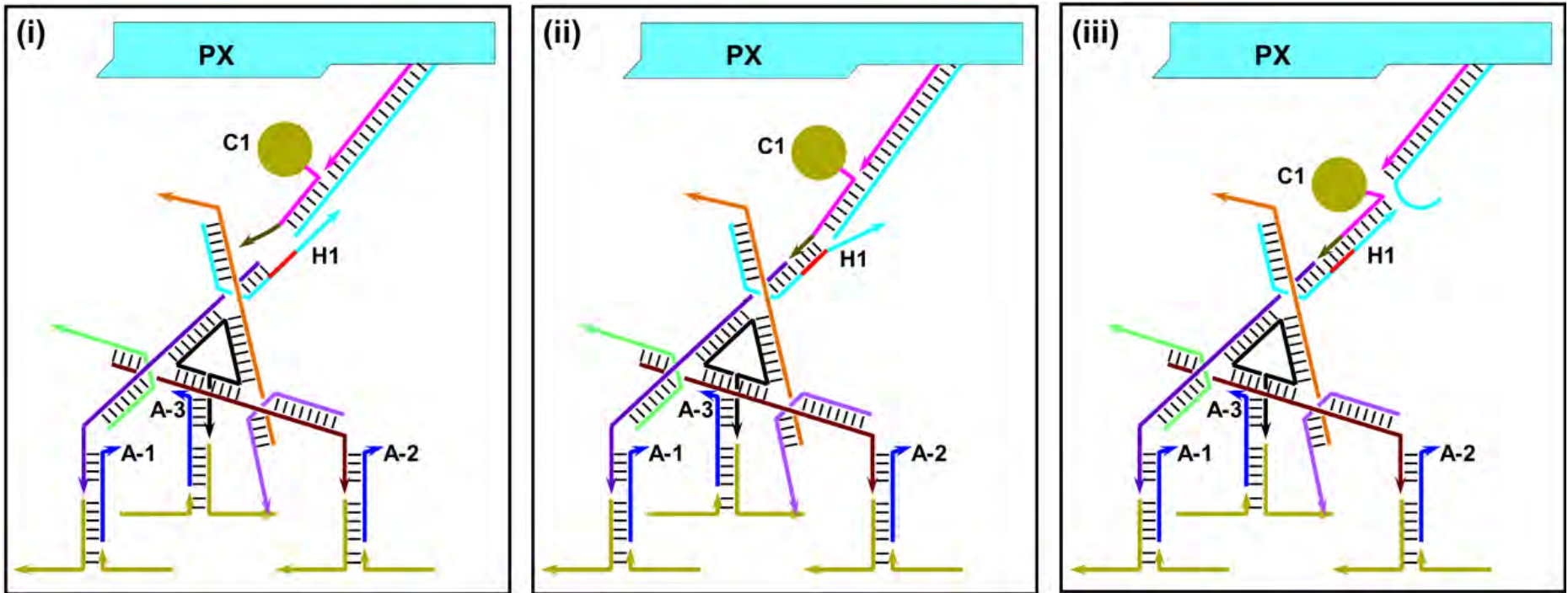

Diversity of Products

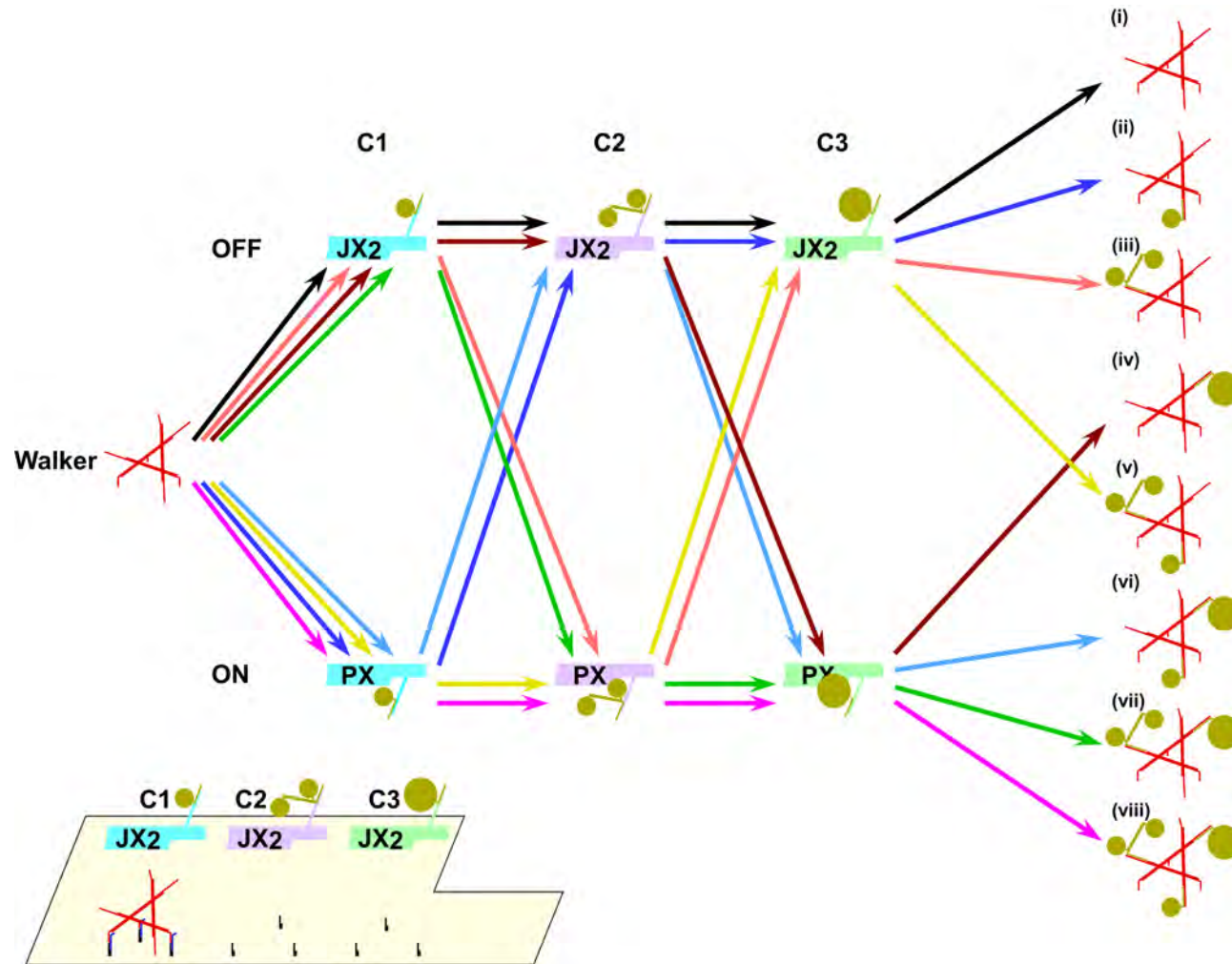

Distinct Programmed Products

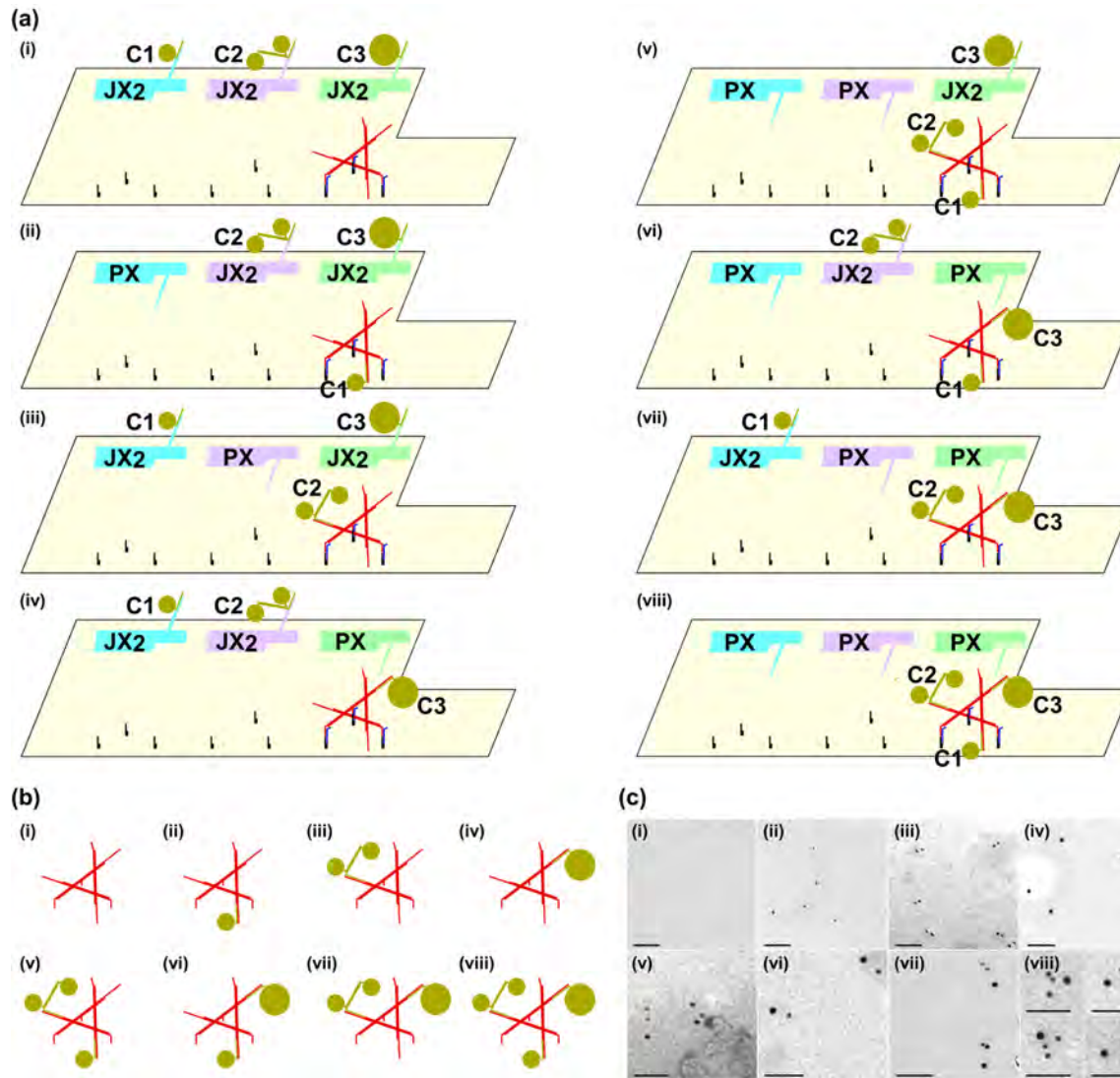

Summary of Results

- **Polyhedral Catenanes, Knots and Borromean Rings can be Assembled from Branched DNA by Ligation.**
- **2D Lattices with Tunable Features have been Made from DNA Tile and Origami Components.**
- **3D Crystals with Tunable Properties have been Self-Assembled and their Structures have been Determined.**
- **Heterologous Species have been Included in DNA Nanoconstructs.**
- **Algorithmic Assembly has been Prototyped and its Problems have been Addressed.**
- **Nanomechanical Devices have been Assembled from Branched DNA, Including Shape-Shifters and Walkers. These have been Combined on an Origami Surface to Produce a Nano-Scale Assembly Line.**



SUPPORT

National Institute of General Medical Sciences (1982-)

Office of Naval Research (1989-2004; 2009-)

National Science Foundation (1997-)

DARPA/AFOSR (2001-2003)

Army Research Office (2005-)

W. M. Keck Foundation (2006-2010)

Nanoscience Technologies, Inc. (2003-2006)

Department of Energy -- (2006-2008; 2012-)

WEB PAGE

[HTTP://SEEMANLAB4.CHEM.NYU.EDU](http://seemanlab4.chem.nyu.edu)