

Certifying almost all quantum states with few single-qubit measurements

Hsin-Yuan Huang (Robert)

with John Preskill and Mehdi Soleimanifar

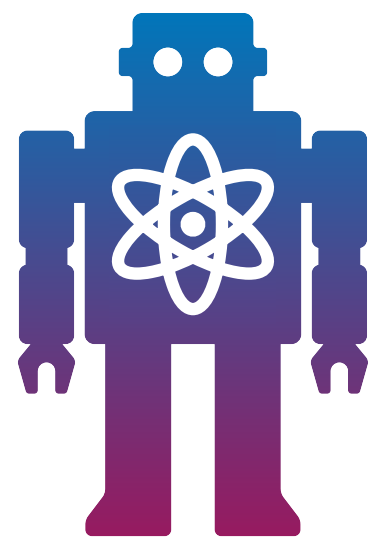

Caltech



Motivation

- Quantum systems with **intricate entanglement** are pivotal in quantum information science.

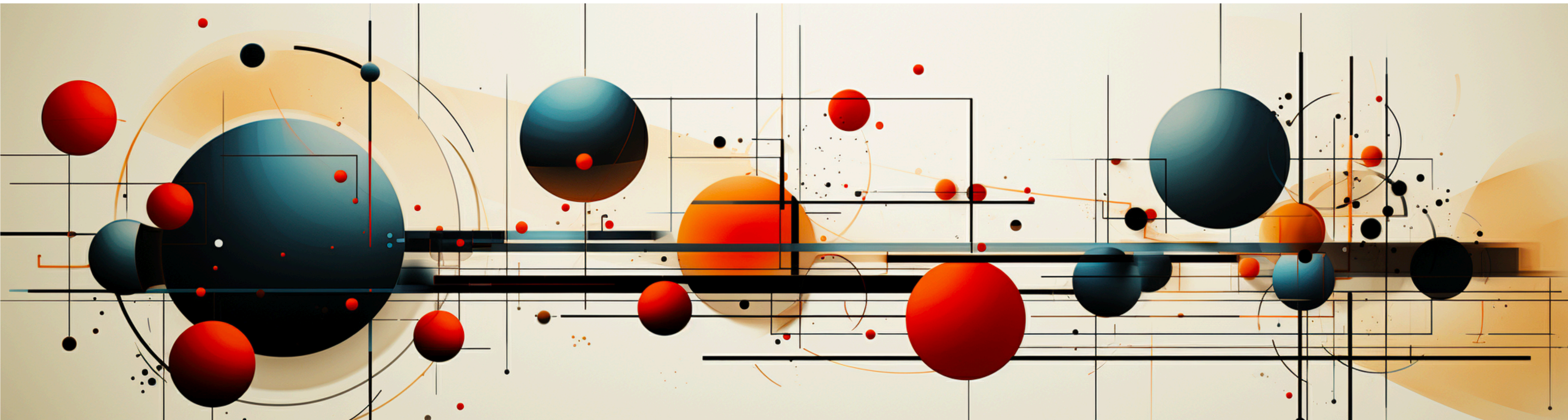

Motivation

- Quantum systems with **intricate entanglement** are pivotal in quantum information science.
- To understand if we have created the desired quantum system in the lab, we need to perform **certification**.



What is Certification?

- We have a desired n -qubit state $|\psi\rangle$, which is our target state.
- We have an n -qubit state ρ created in the experimental lab.
- **Task:** Test if ρ is close to $|\psi\rangle\langle\psi|$ or not from data?
($\langle\psi|\rho|\psi\rangle$ is close to 1)



Motivation

- Many techniques have been proposed for **certification**.
- However, it remains **experimentally challenging** to certify highly-entangled quantum many-body systems.



How to Certify?

- **Approach 0: Direct measurement**

$$|\psi\rangle = U|0^n\rangle$$

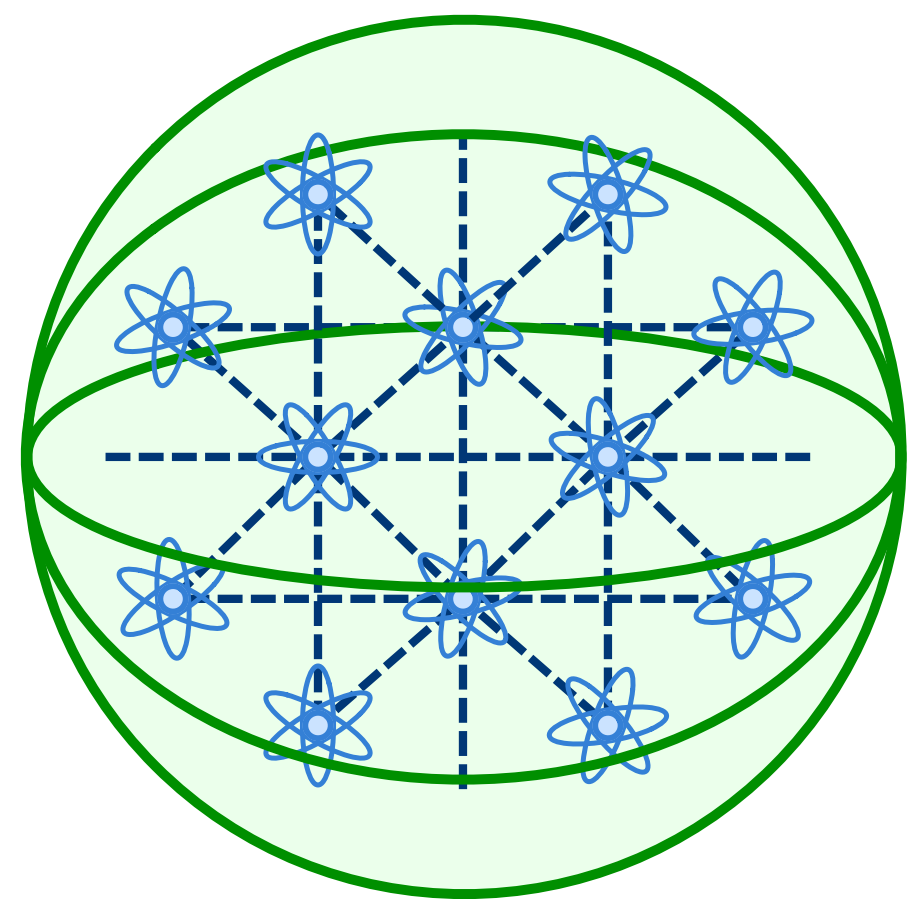

Quantum state

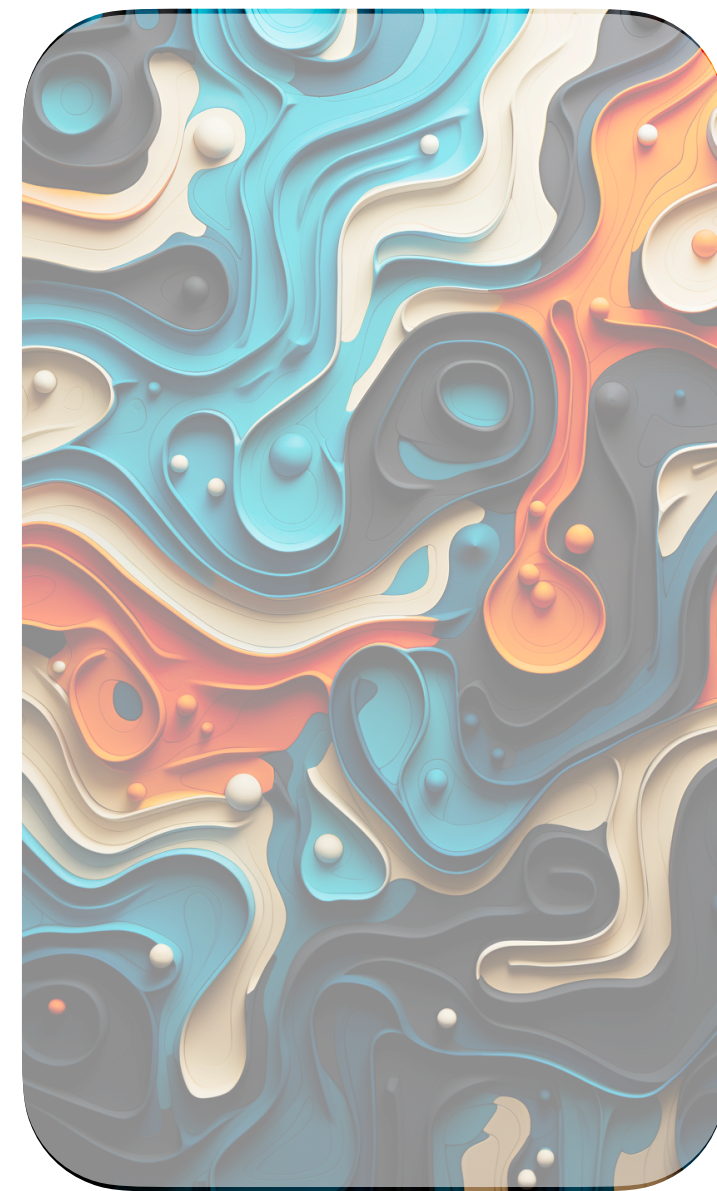
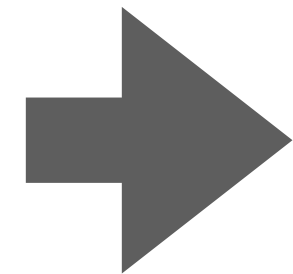

U^\dagger

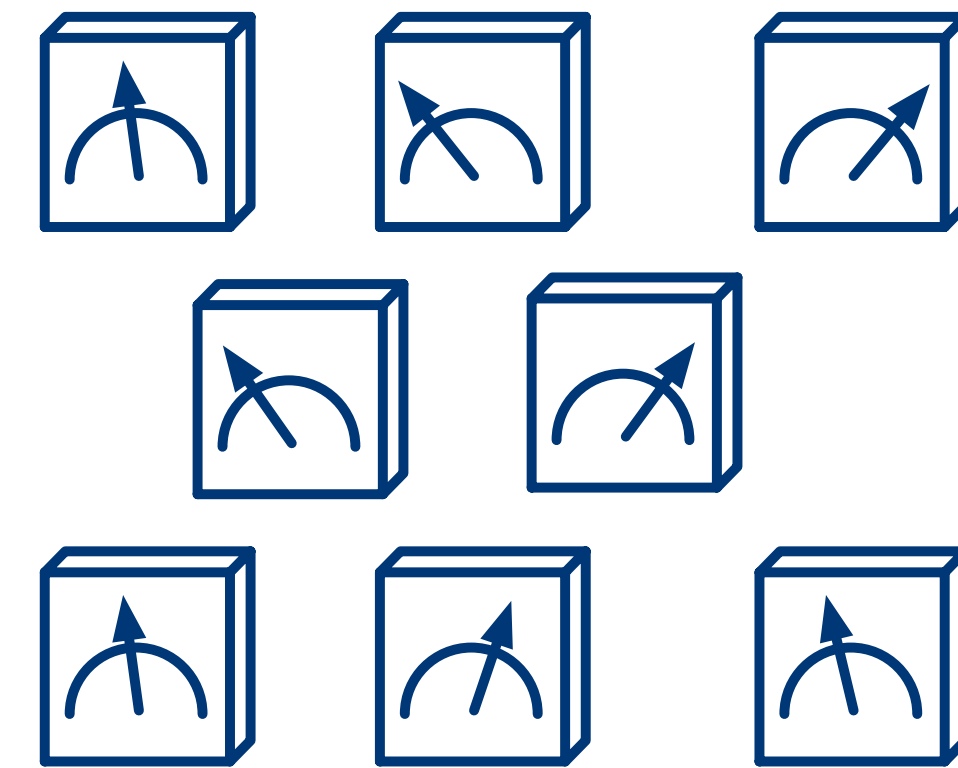
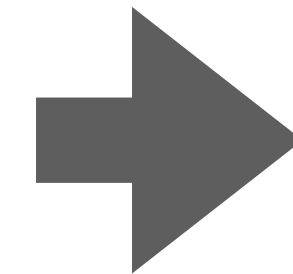

Single-qubit
Measurement

How to Certify?

- **Approach 0:** Direct measurement
- **Challenge:**

If we can assume U^\dagger is perfect, then U should be perfect too.

In this world, ρ can be created to be $|\psi\rangle$ perfectly.

So we don't need to do any certification.



How to Certify?

- **Approach 1:** Random Clifford measurements (classical shadow)

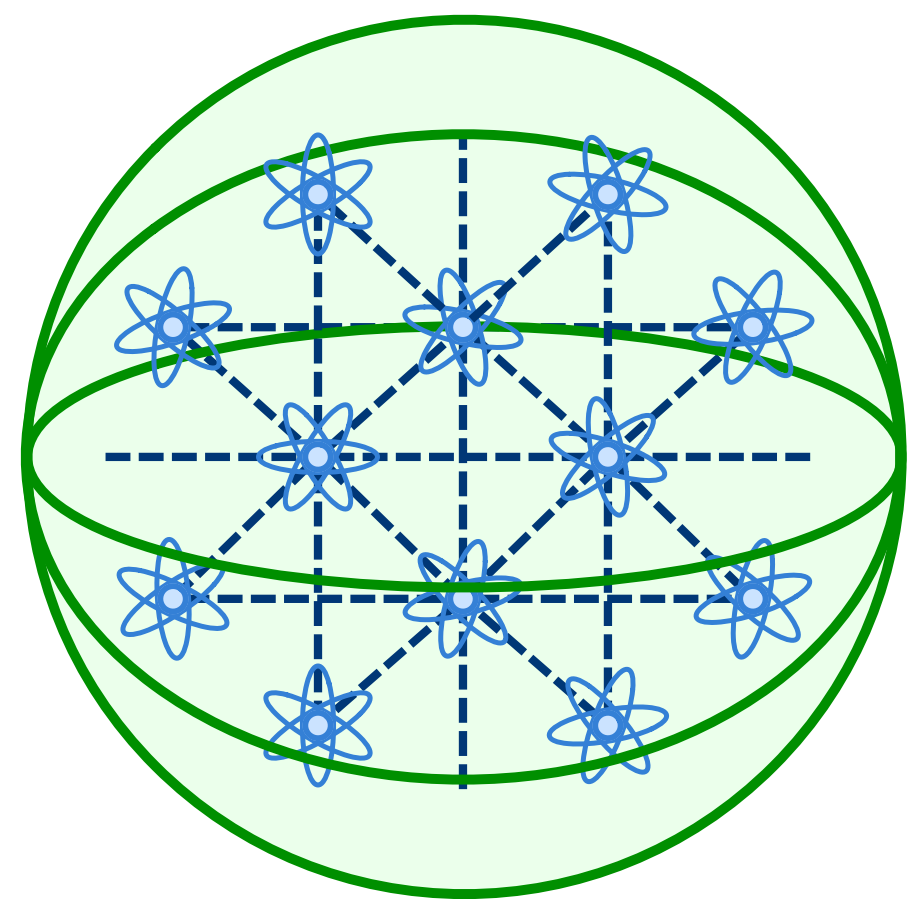

Quantum state

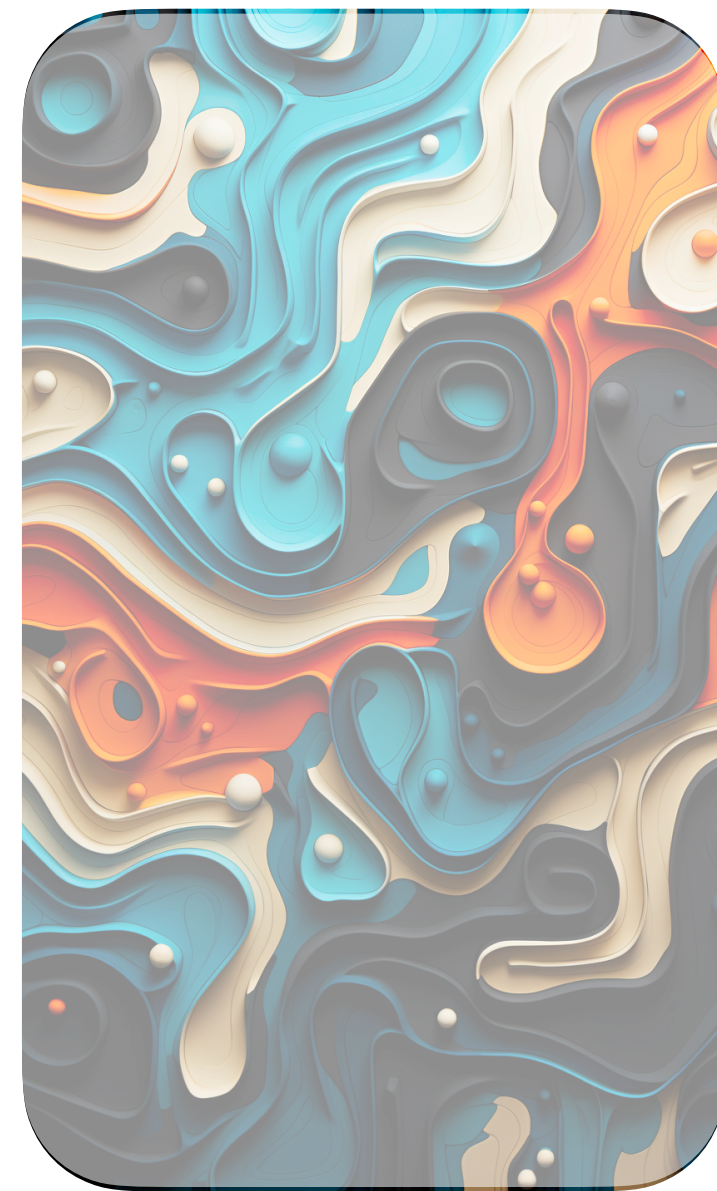
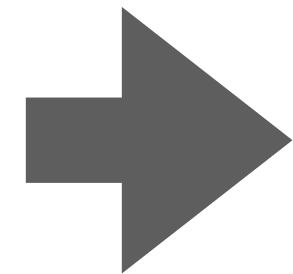

Random
Clifford Circuit

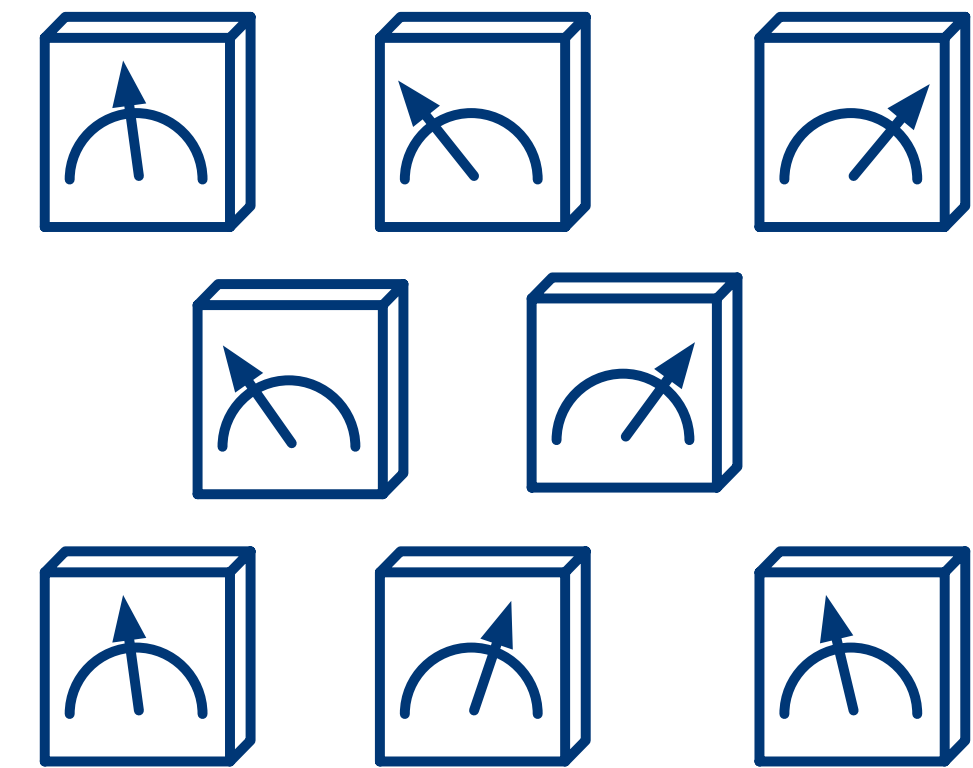
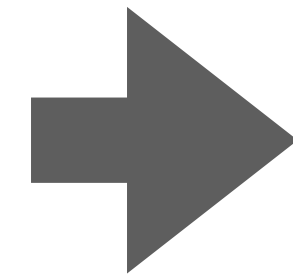

Single-qubit
Measurement

How to Certify?

- **Approach 1:** Random Clifford measurements (classical shadow)
- **Advantage:**
Only needs depth- n random Clifford circuits on ρ
- **Challenge:**
Implementing depth- n random Clifford circuits is still **experimentally challenging**.



How to Certify?

- **Approach 2:** Random Pauli measurements (classical shadow)

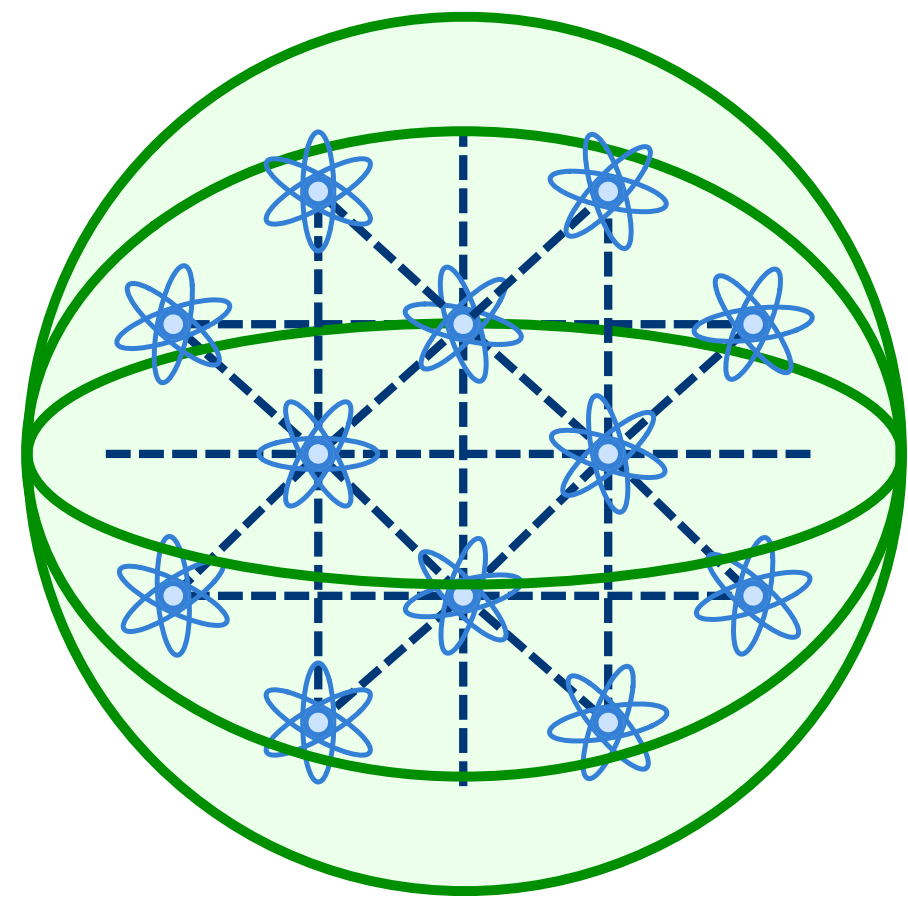

Quantum state

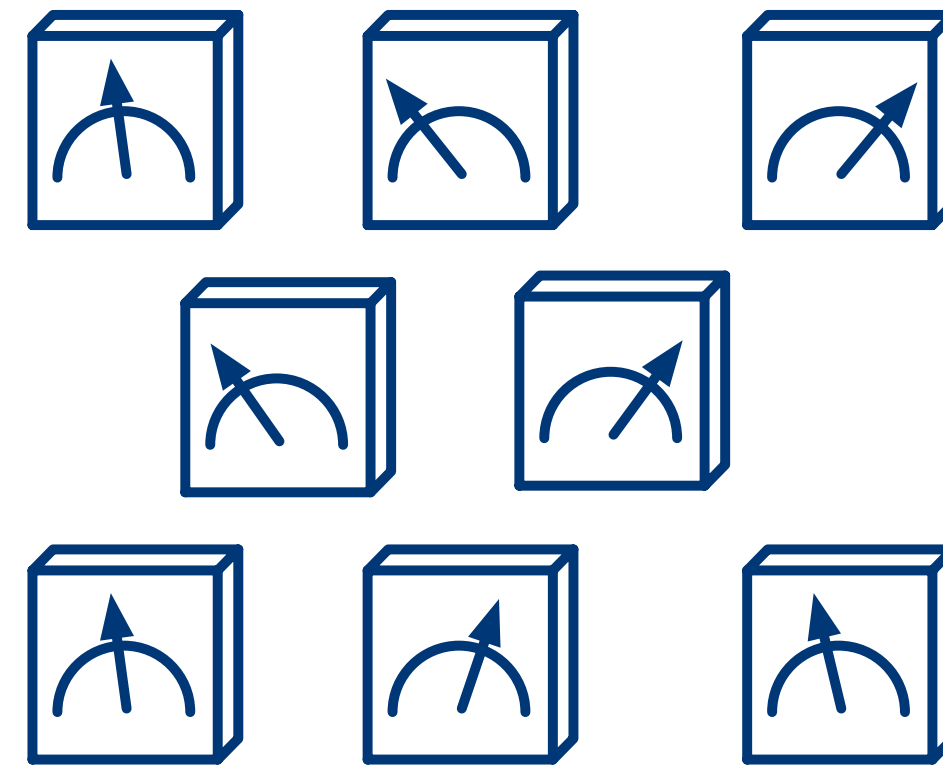
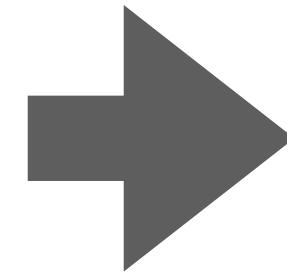

Single-qubit
Measurement

How to Certify?

- **Approach 2:** Random Pauli measurements (classical shadow)
- **Advantage:**
Only needs **single-qubit** measurements on ρ
- **Challenge:**
Requires **$\exp(n)$** measurements for most target $|\psi\rangle$
especially when $|\psi\rangle$ is highly entangled.



How to Certify?

- **Approach 3: Cross-entropy benchmark (XEB)**

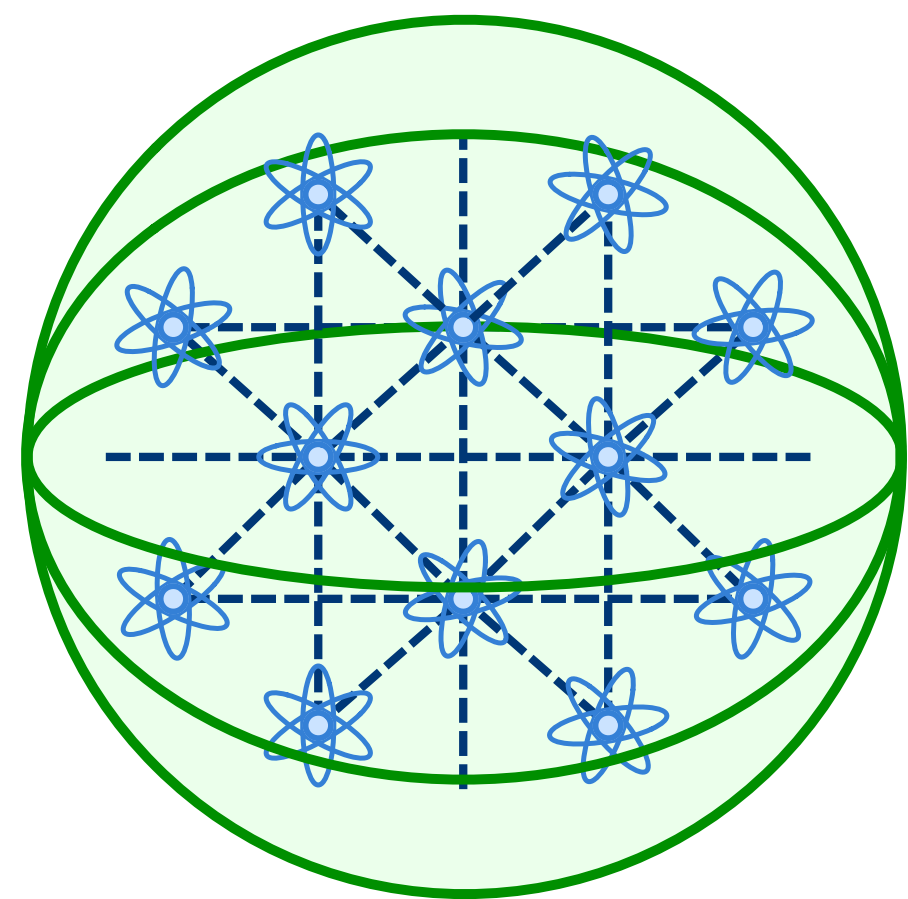

Quantum state

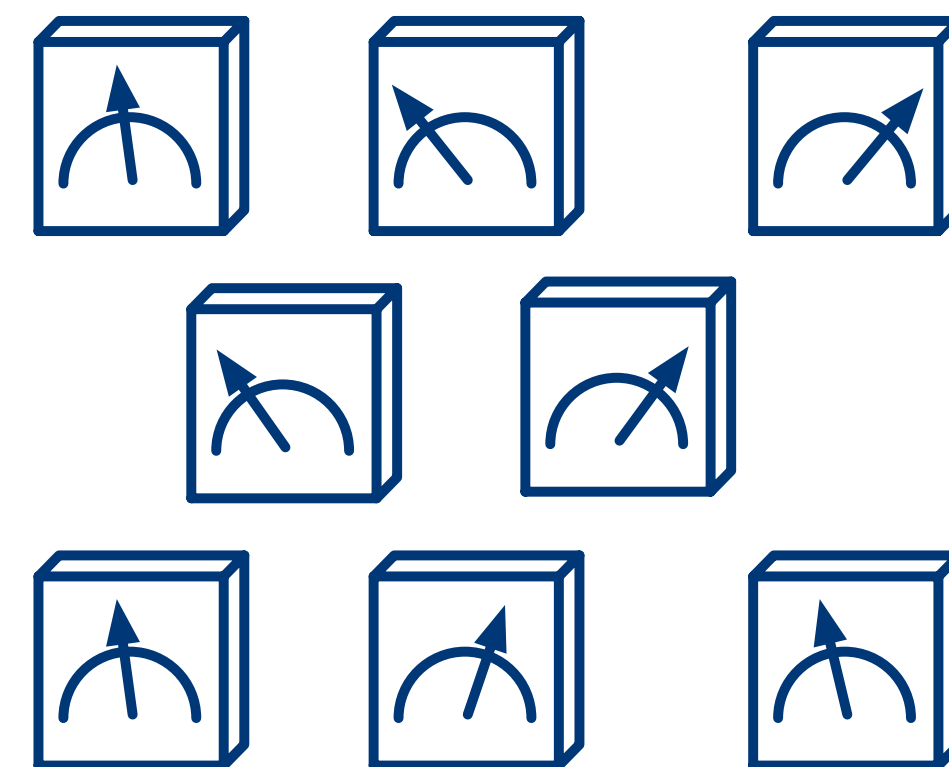
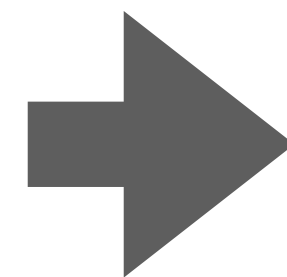

Single-qubit
Measurement
(all Z bases)

How to Certify?

- **Approach 3:** Cross-entropy benchmark (XEB)
- **Advantage:**
Only needs **single-qubit** measurements (Z-basis) on ρ
- **Challenge:**
Does not rigorously address the certification task.
 ρ can be **far** from $|\psi\rangle\langle\psi|$ despite perfect XEB score.



Existing Challenges

- All existing certification protocols either



Existing Challenges

- All existing certification protocols either
 - a. Require **deep** quantum circuits before measurements



Existing Challenges

- All existing certification protocols either
 - a. Require deep quantum circuits before measurements
 - b. Use **exponentially** many measurements



Existing Challenges

- All existing certification protocols either
 - a. Require **deep** quantum circuits before measurements
 - b. Use **exponentially** many measurements
 - c. Apply only for **specialized** target state $|\psi\rangle$



Existing Challenges

- All existing certification protocols either
 - a. Require **deep** quantum circuits before measurements
 - b. Use **exponentially** many measurements
 - c. Apply only for **specialized** target state $|\psi\rangle$
 - d. **Lack** rigorous guarantees



Question

Can we rigorously certify **highly-entangled** quantum states from performing **few single-qubit** measurements?

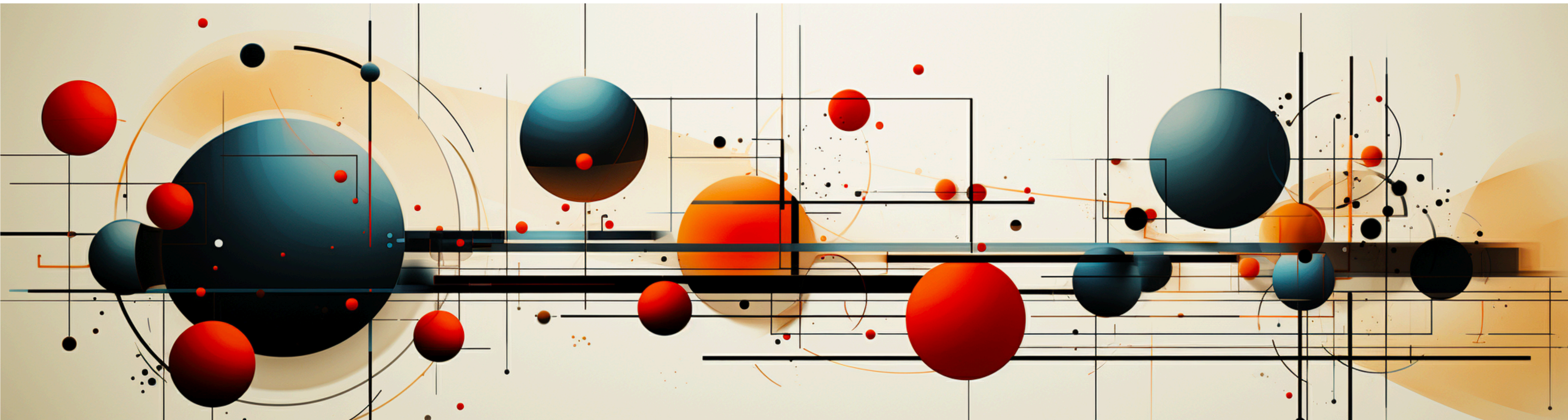

Question

Can we rigorously certify **almost all** quantum states from performing **few single-qubit** measurements?

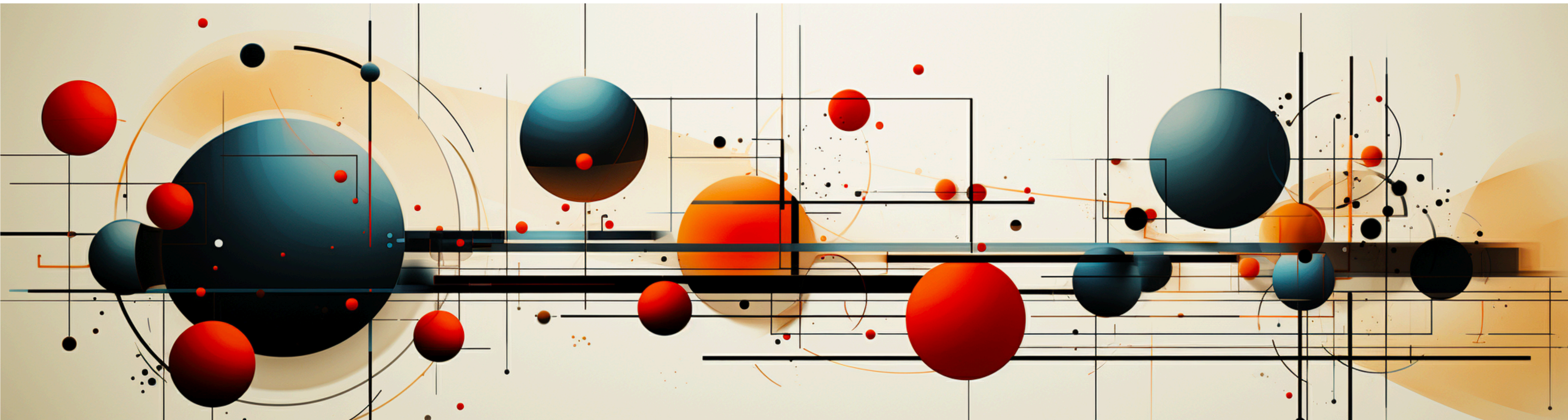

Outline

- Theorem
- Protocol
- Applications



Outline

- Theorem
- Protocol
- Applications



Certification

Theorem 1

For almost all n -qubit state $|\psi\rangle$, we can certify that ρ is close to $|\psi\rangle\langle\psi|$ using only $\mathcal{O}(n^2)$ single-qubit measurements.

Certification

Theorem 1

For almost all n -qubit state $|\psi\rangle$, we can certify that ρ is close to $|\psi\rangle\langle\psi|$ using only $\mathcal{O}(n^2)$ single-qubit measurements.

- The certification procedure applies to any ρ .

Certification

Theorem 1

For almost all n -qubit state $|\psi\rangle$, we can certify that ρ is close to $|\psi\rangle\langle\psi|$ using only $\mathcal{O}(n^2)$ single-qubit measurements.

- The certification procedure applies to any ρ .
- $\mathcal{O}(n^2)$ is enough even when $|\psi\rangle$ has $\exp(n)$ circuit complexity.

Relaxation Time

- Consider an n -qubit target state $|\psi\rangle$.
- Choose a basis $|b\rangle$, where $b \in \{0,1\}^n$ is a bitstring.
- Let $\pi(b) = |\langle b|\psi\rangle|^2$ be the **measurement distribution**.

Boolean
Hypercube

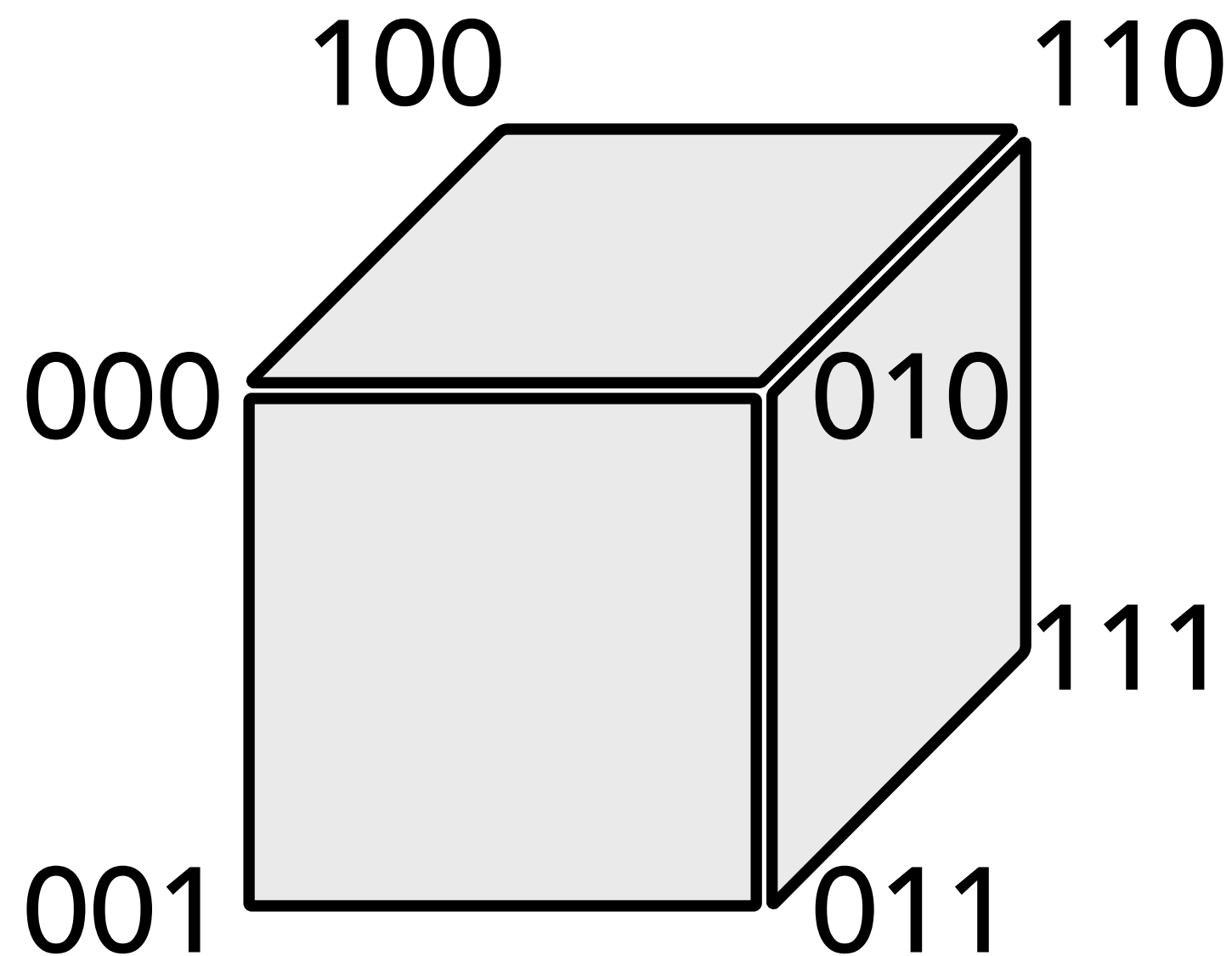

Relaxation Time

- Let $\pi(b) = |\langle b|\psi\rangle|^2$ be the **measurement distribution**.
- Consider a random walk on n -bit Boolean hypercube.

Boolean
Hypercube

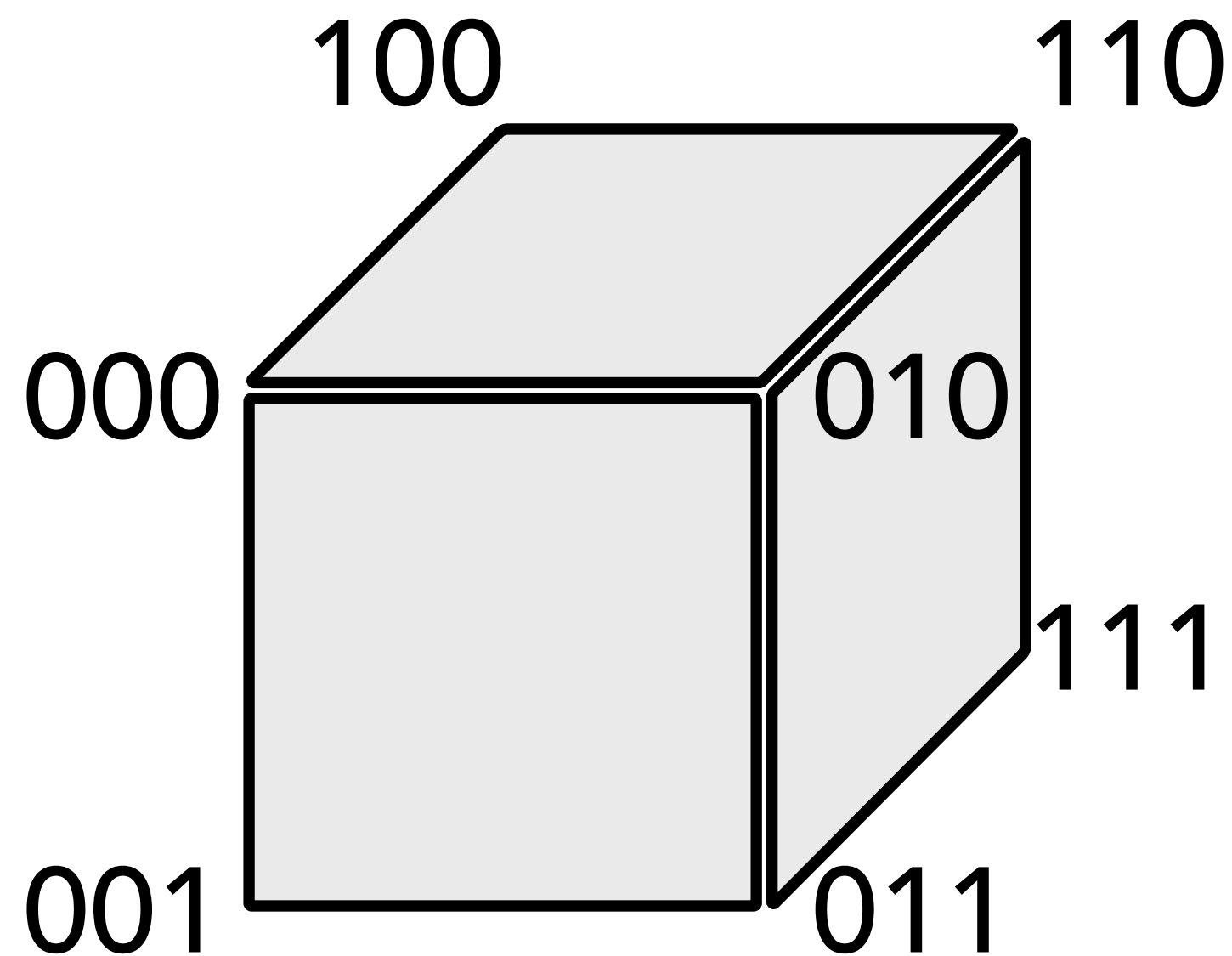

Relaxation Time

- Let $\pi(b) = |\langle b|\psi\rangle|^2$ be the **measurement distribution**.
- Consider a random walk on n -bit Boolean hypercube.

Boolean
Hypercube

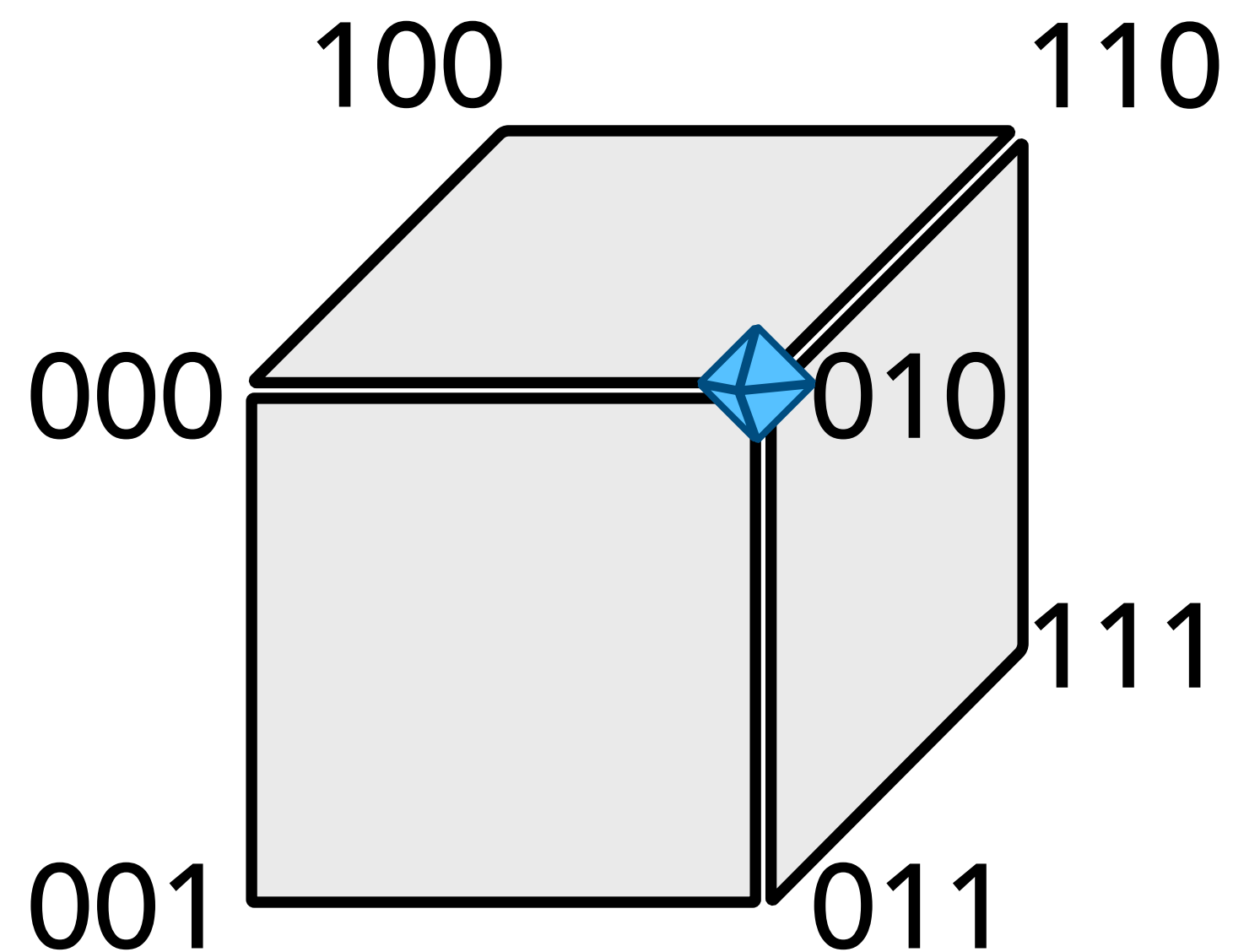



 = b

Relaxation Time

- Let $\pi(b) = |\langle b|\psi\rangle|^2$ be the **measurement distribution**.
- Consider a random walk on n -bit Boolean hypercube.

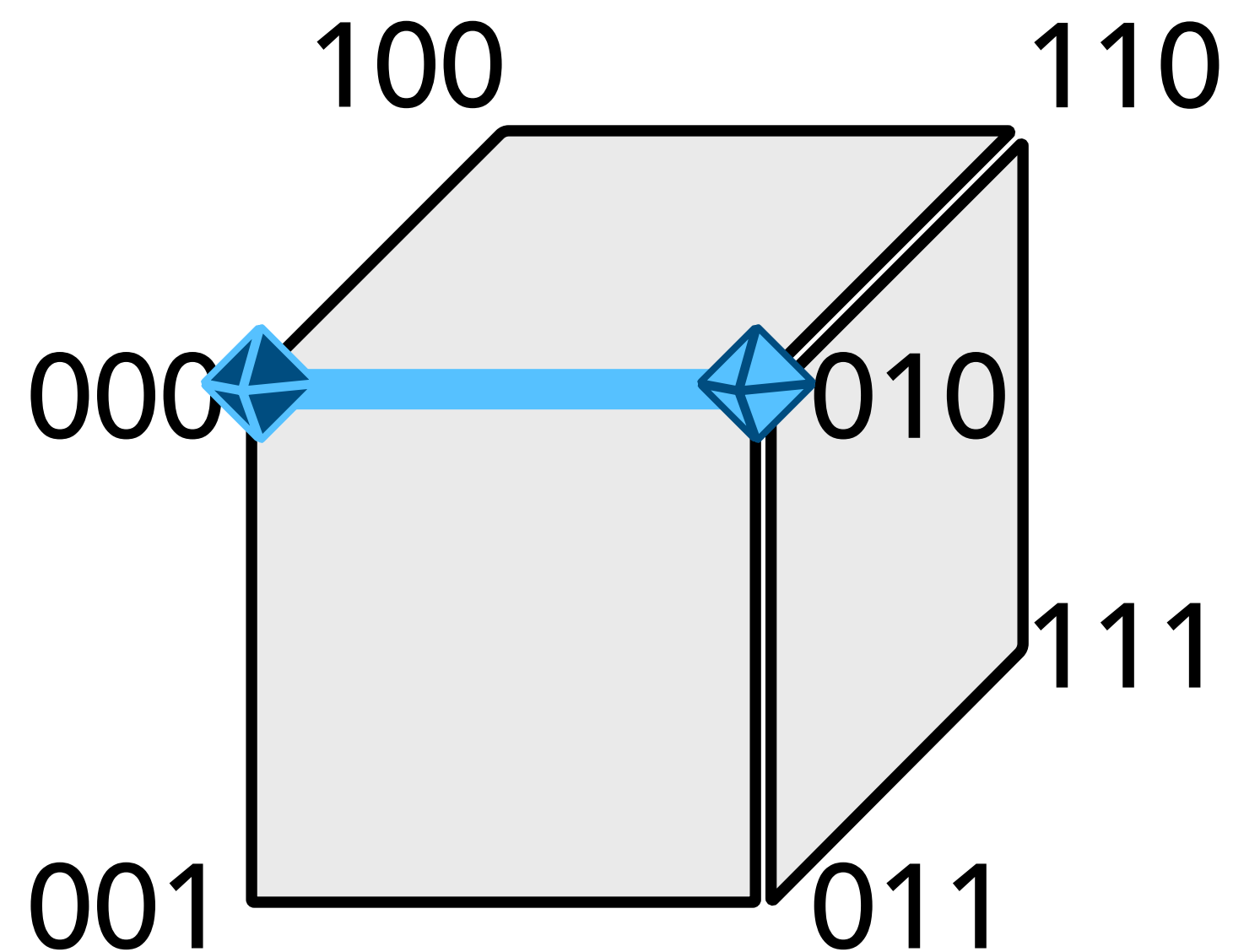
Boolean
Hypercube



 = b
 = b'

Relaxation Time

- Let $\pi(b) = |\langle b|\psi\rangle|^2$ be the **measurement distribution**.
- Consider a random walk on n -bit Boolean hypercube.

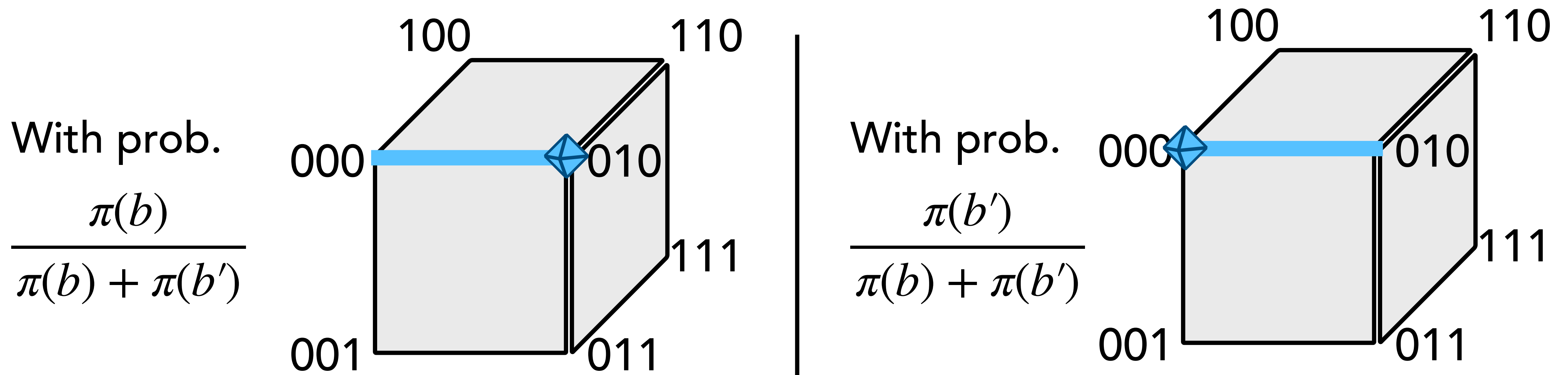

Relaxation Time

- Let $\pi(b) = |\langle b|\psi\rangle|^2$ be the **measurement distribution**.
- Let τ be the time the random walk takes to relax to stationary π .

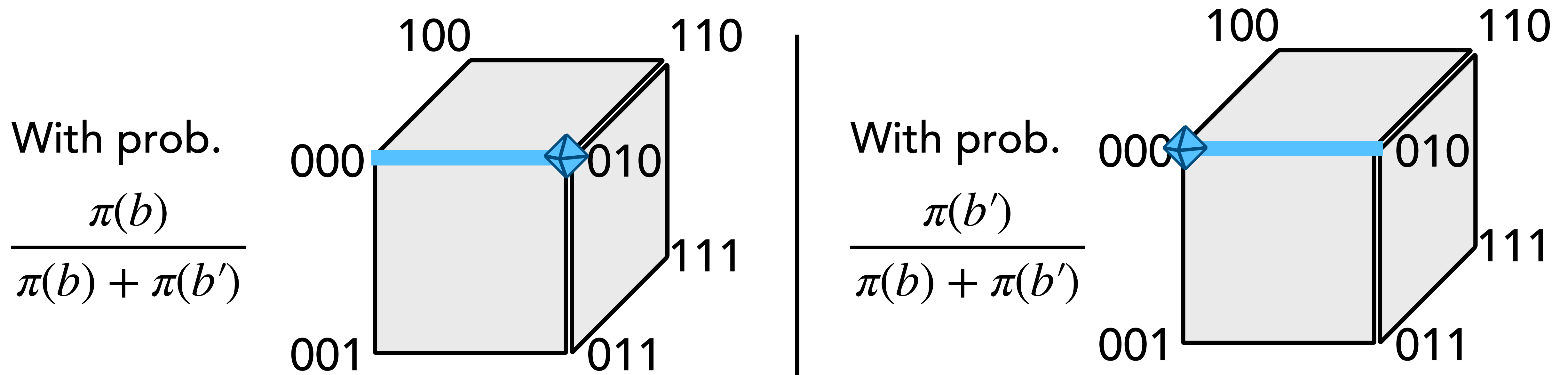

Certification

Theorem 2

For an n -qubit state $|\psi\rangle$ with relax. time τ , we can certify that ρ is close to $|\psi\rangle\langle\psi|$ with $\mathcal{O}(\tau)$ single-qubit measurements.

- When restricted to independent Pauli-basis measurements, we need $\mathcal{O}(\tau^2)$ single-qubit measurements.

Outline

- Theorem
- Protocol
- Applications



Outline

- Theorem
- Protocol
- Applications



Measurement Protocol

- Repeat the following measurement a few times.

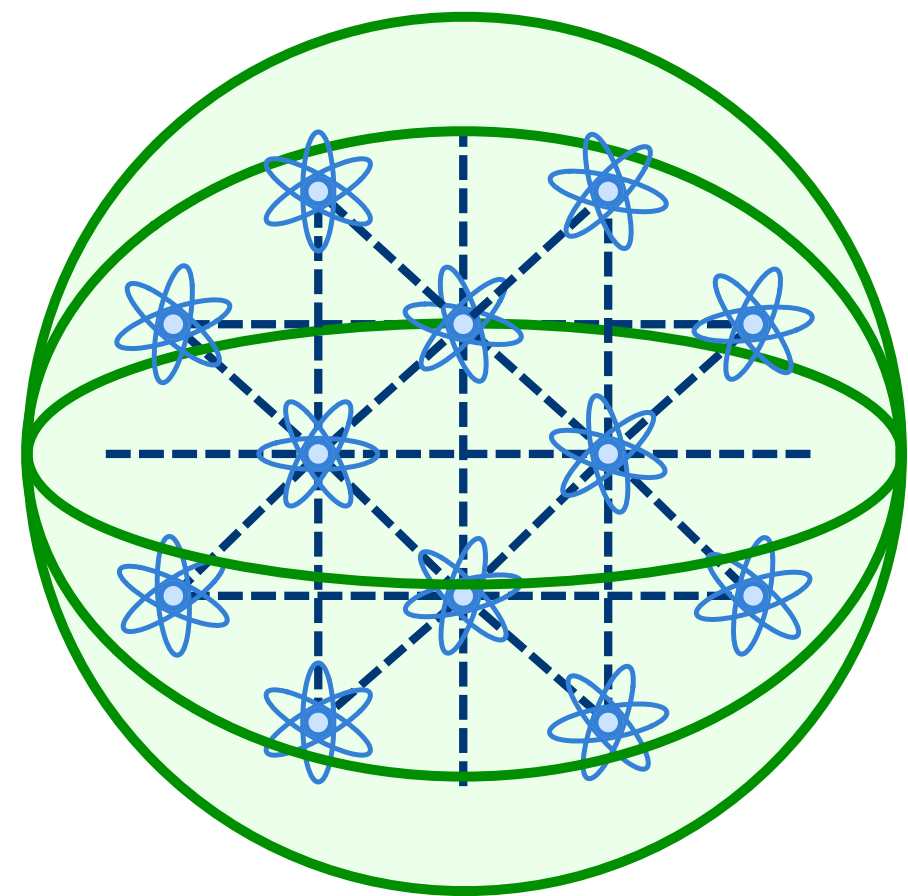

Quantum state

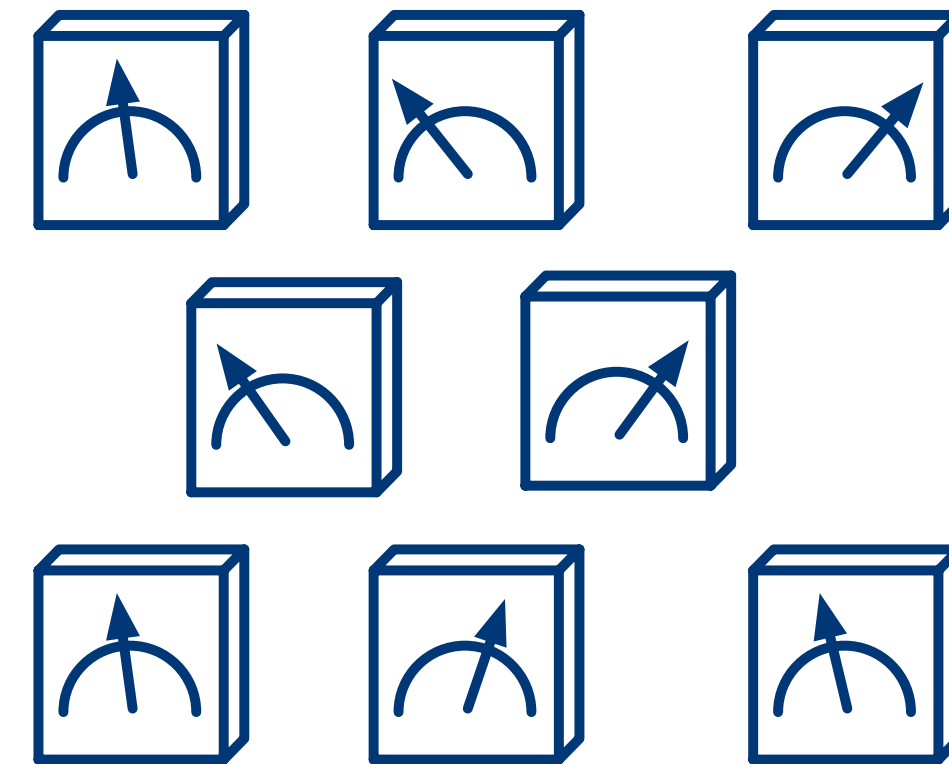
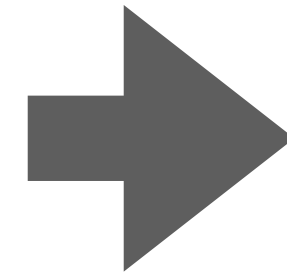

Single-qubit
Measurement

Measurement Protocol

- Pick a random qubit x .

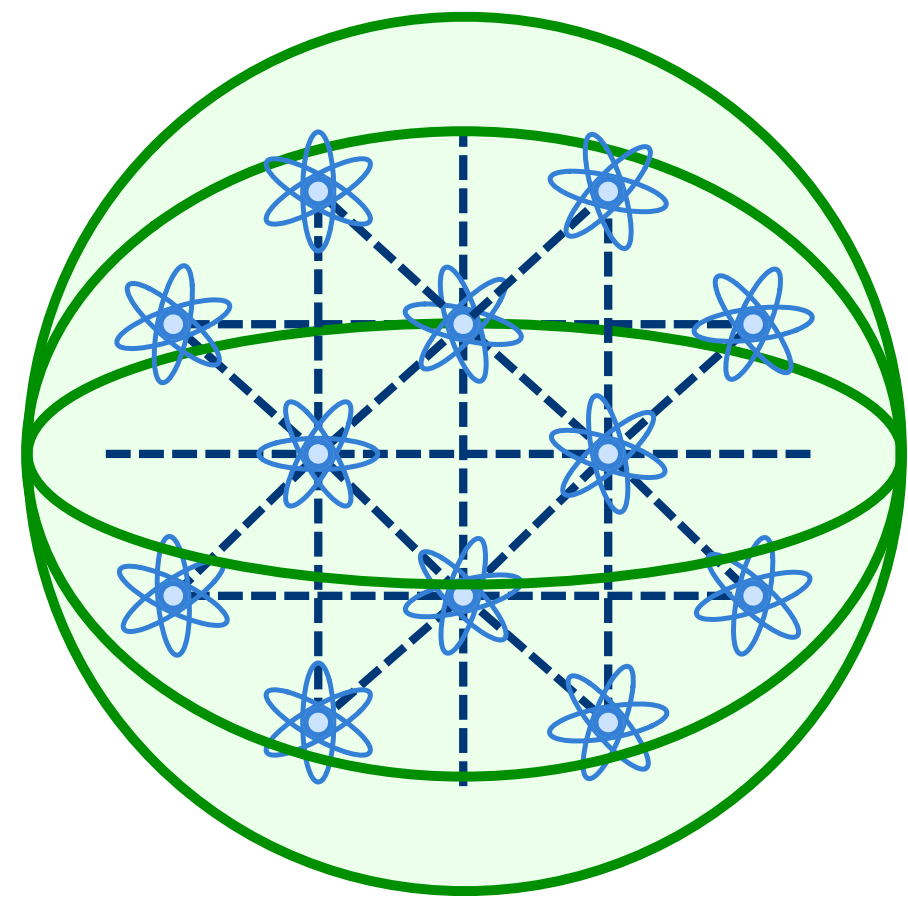

Quantum state

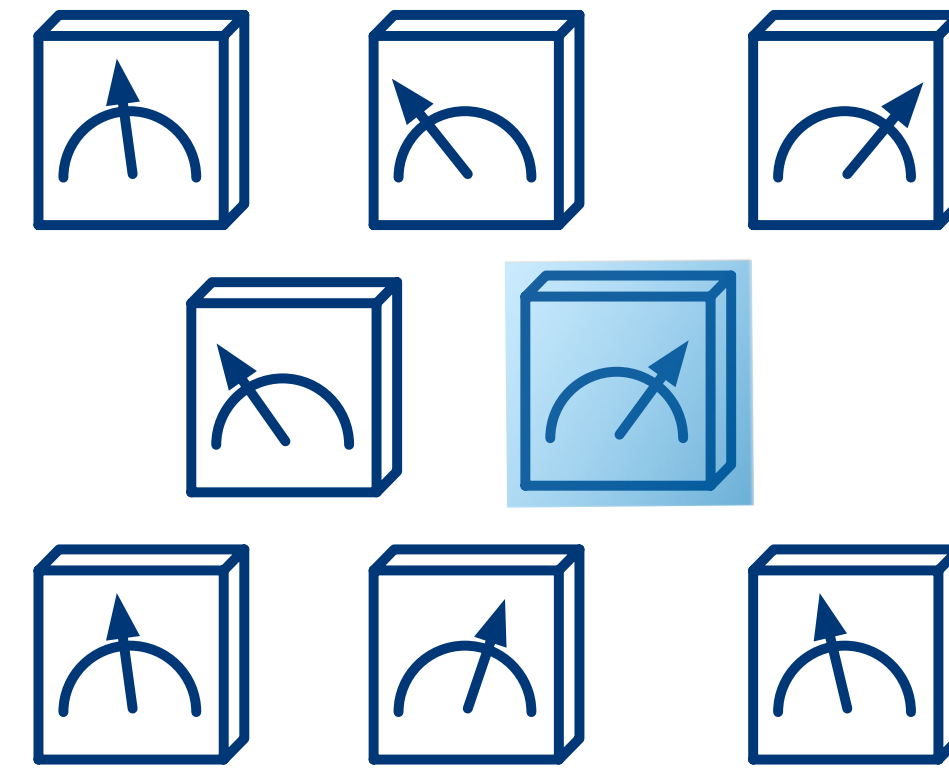
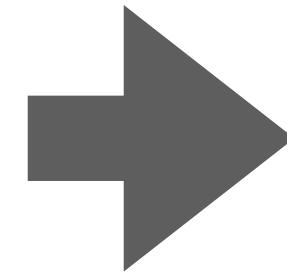

Single-qubit
Measurement

Measurement Protocol

- Pick a random qubit x . Measure all except qubit x in Z basis.

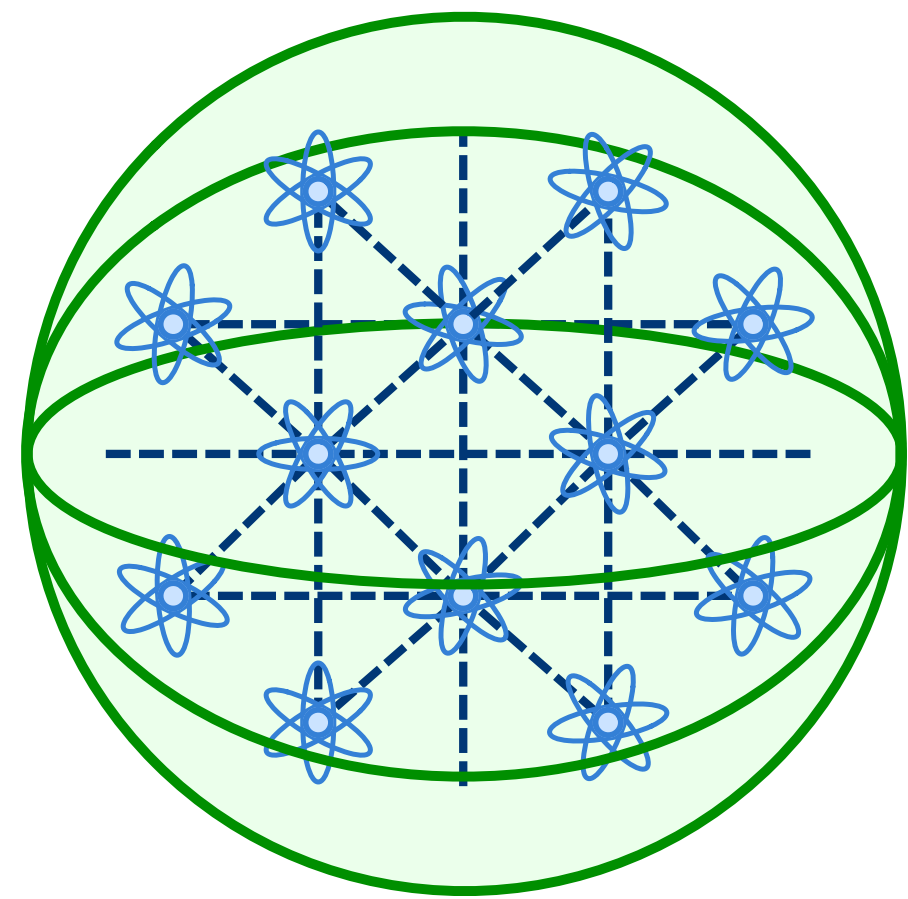

Quantum state

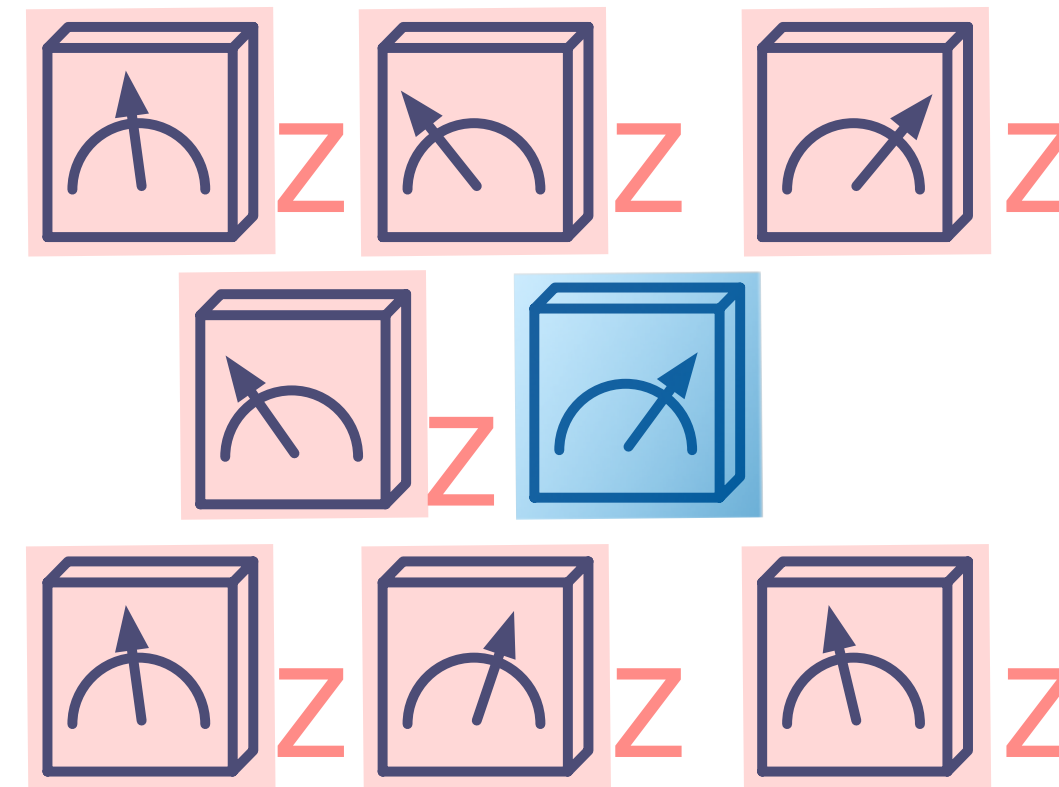
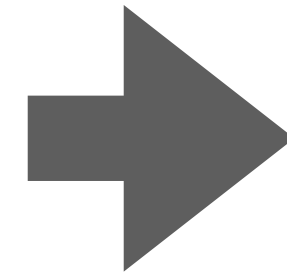

Single-qubit
Measurement

Measurement Protocol

- Pick a random qubit x . Measure x in random X/Y/Z basis.

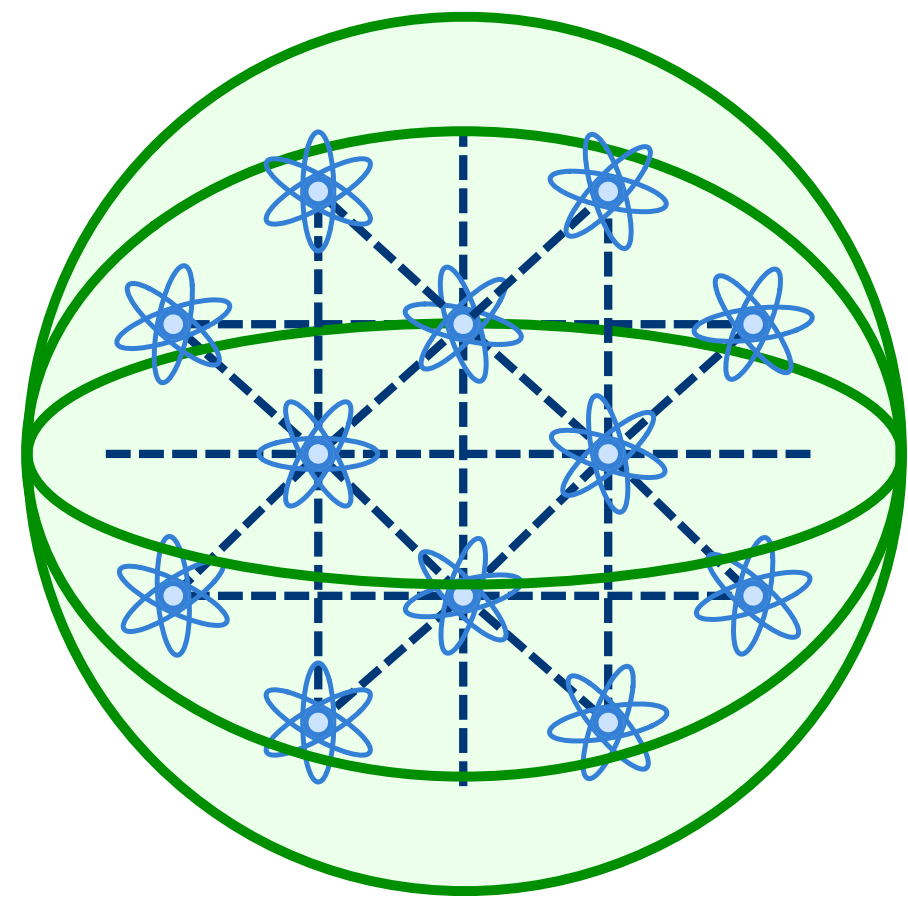

Quantum state

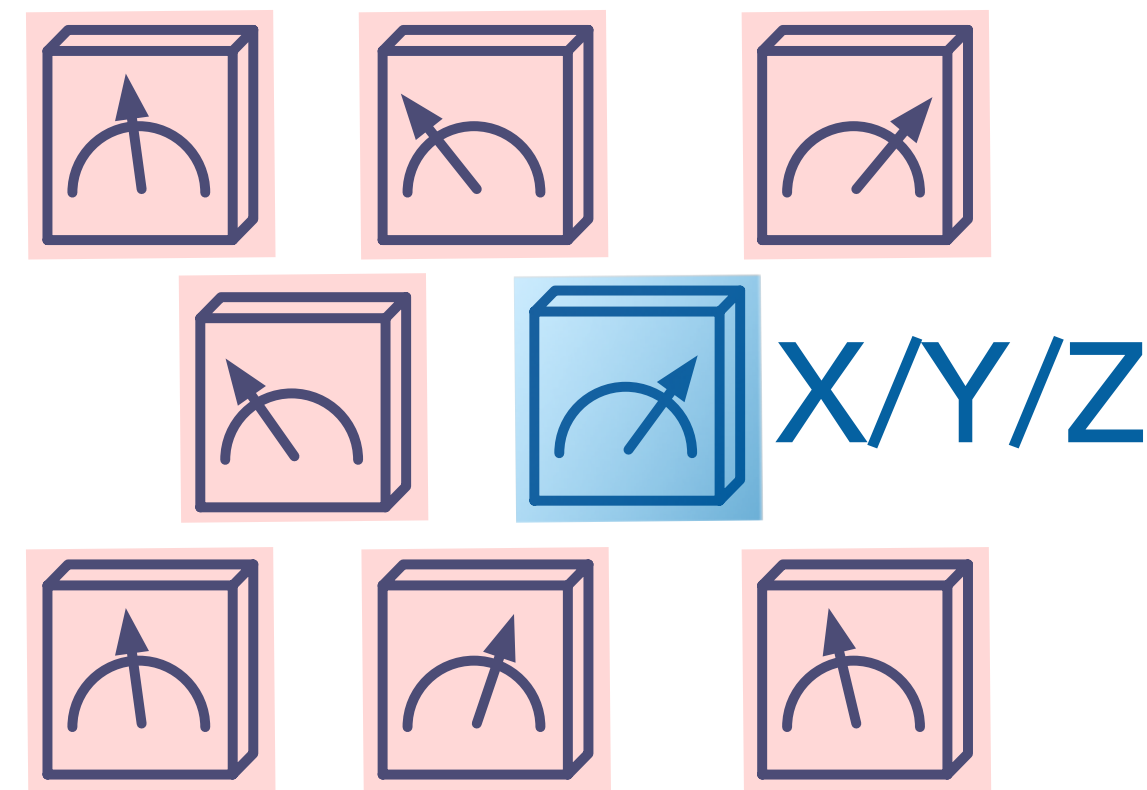
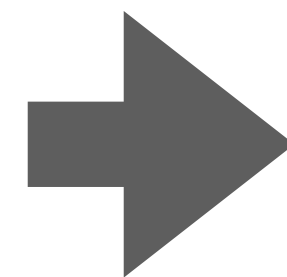

Single-qubit
Measurement

Measurement Protocol

- That's it.

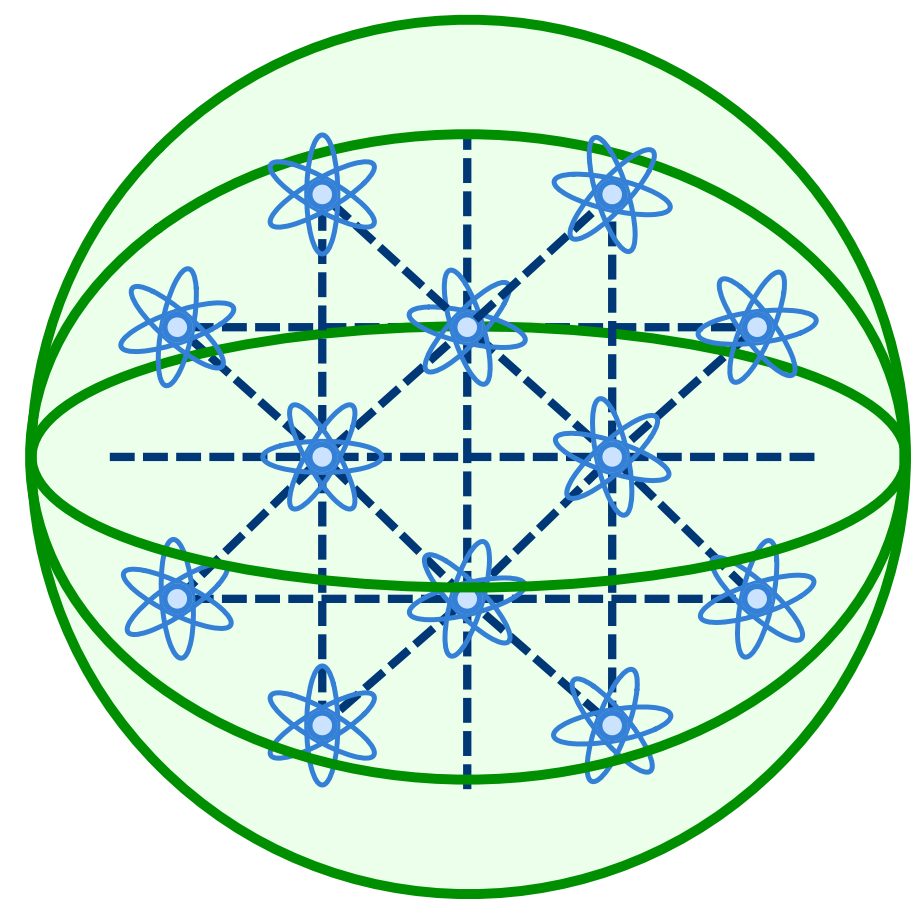

Quantum state

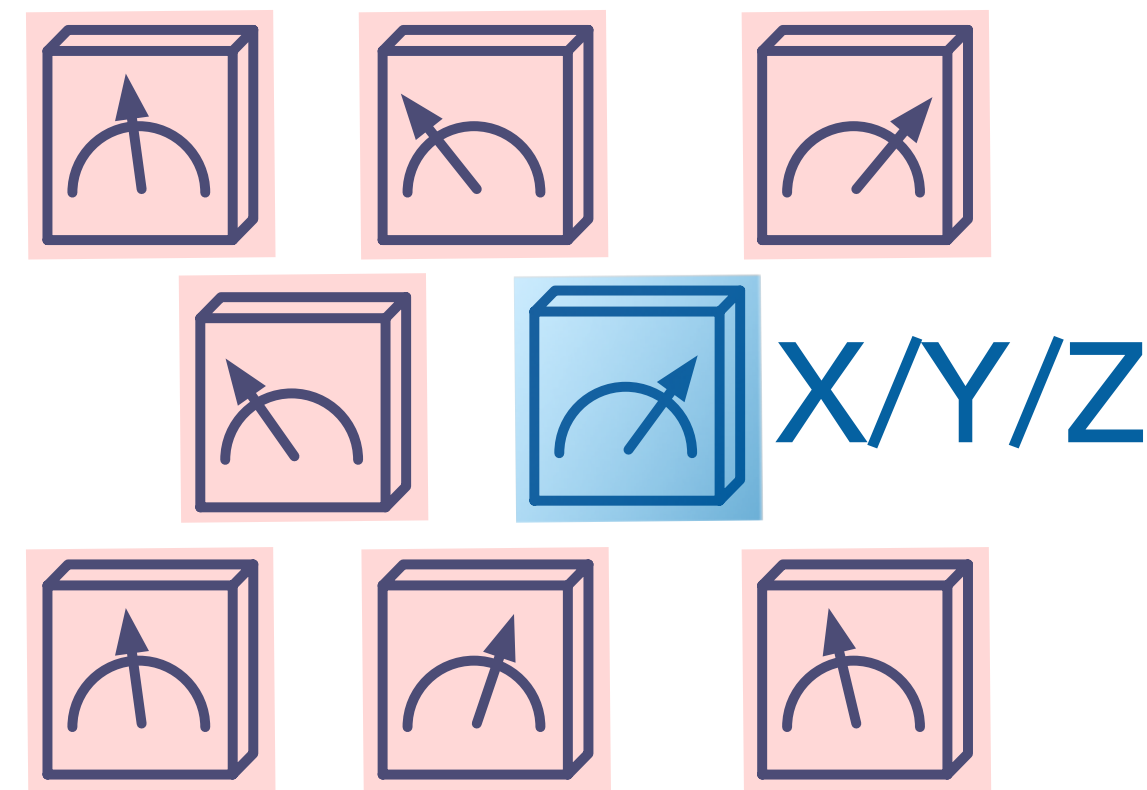
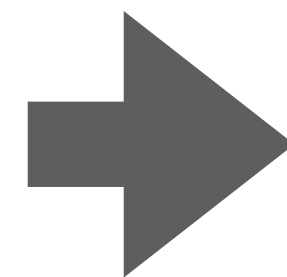

Single-qubit
Measurement

Postprocessing

- The measurement outcomes on  specifies an edge (b_0, b_1) on the Boolean hypercube.

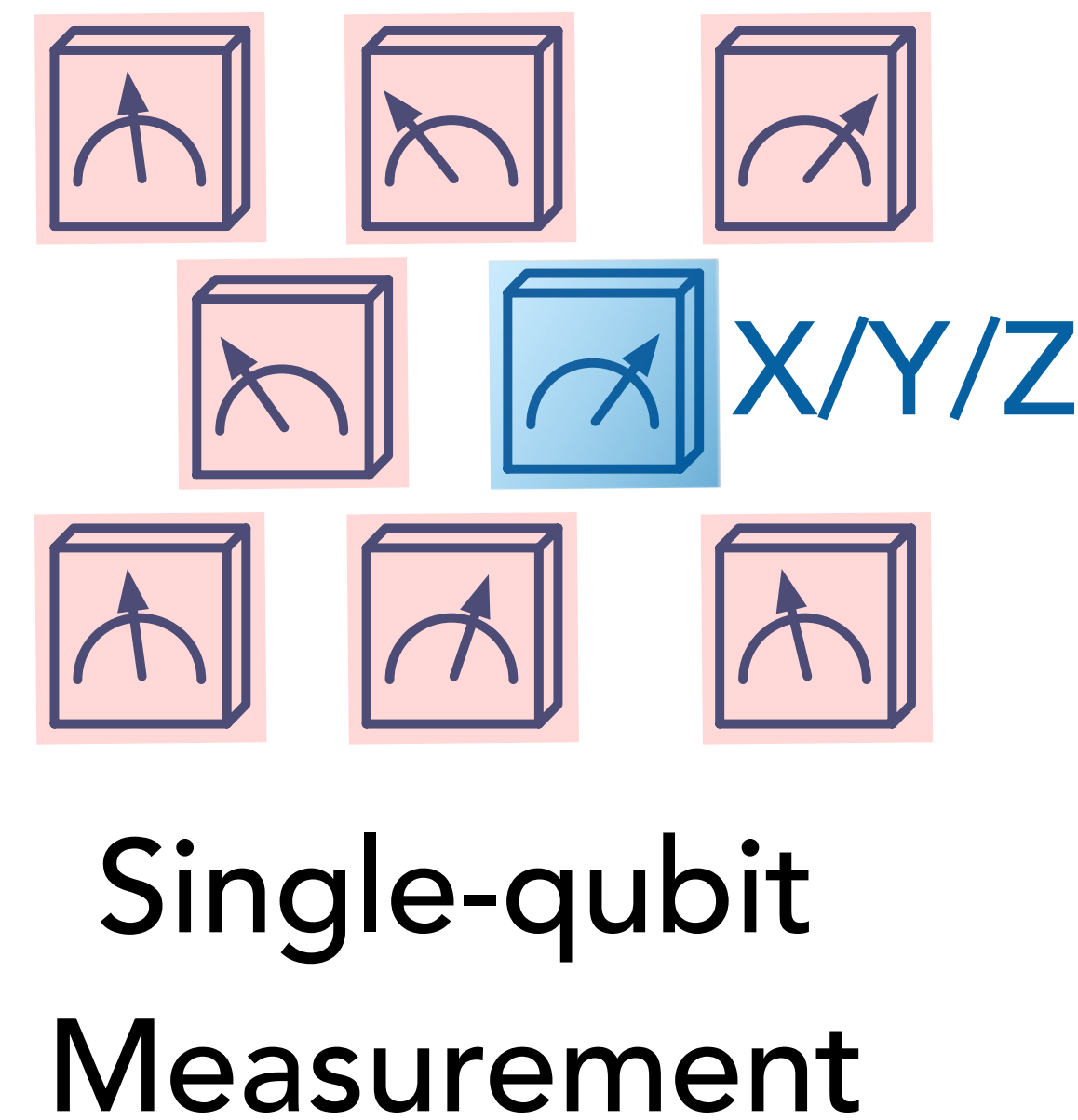
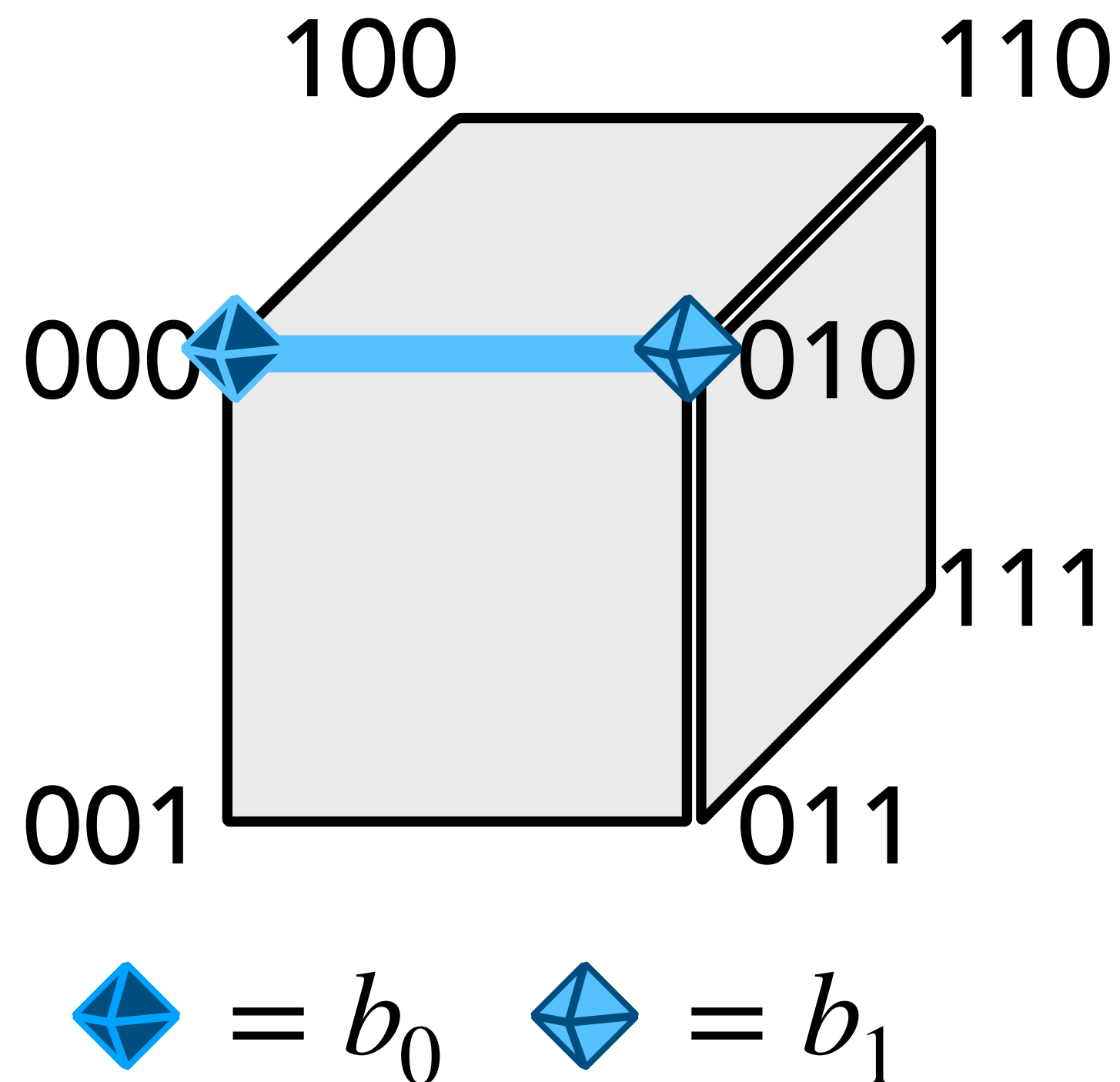

Postprocessing

- The **ideal** post-measurement 1-qubit state $|\psi_{b_0, b_1}\rangle$ on **qubit x** is proportional to $\langle b_0 | \psi \rangle |0\rangle + \langle b_1 | \psi \rangle |1\rangle$.

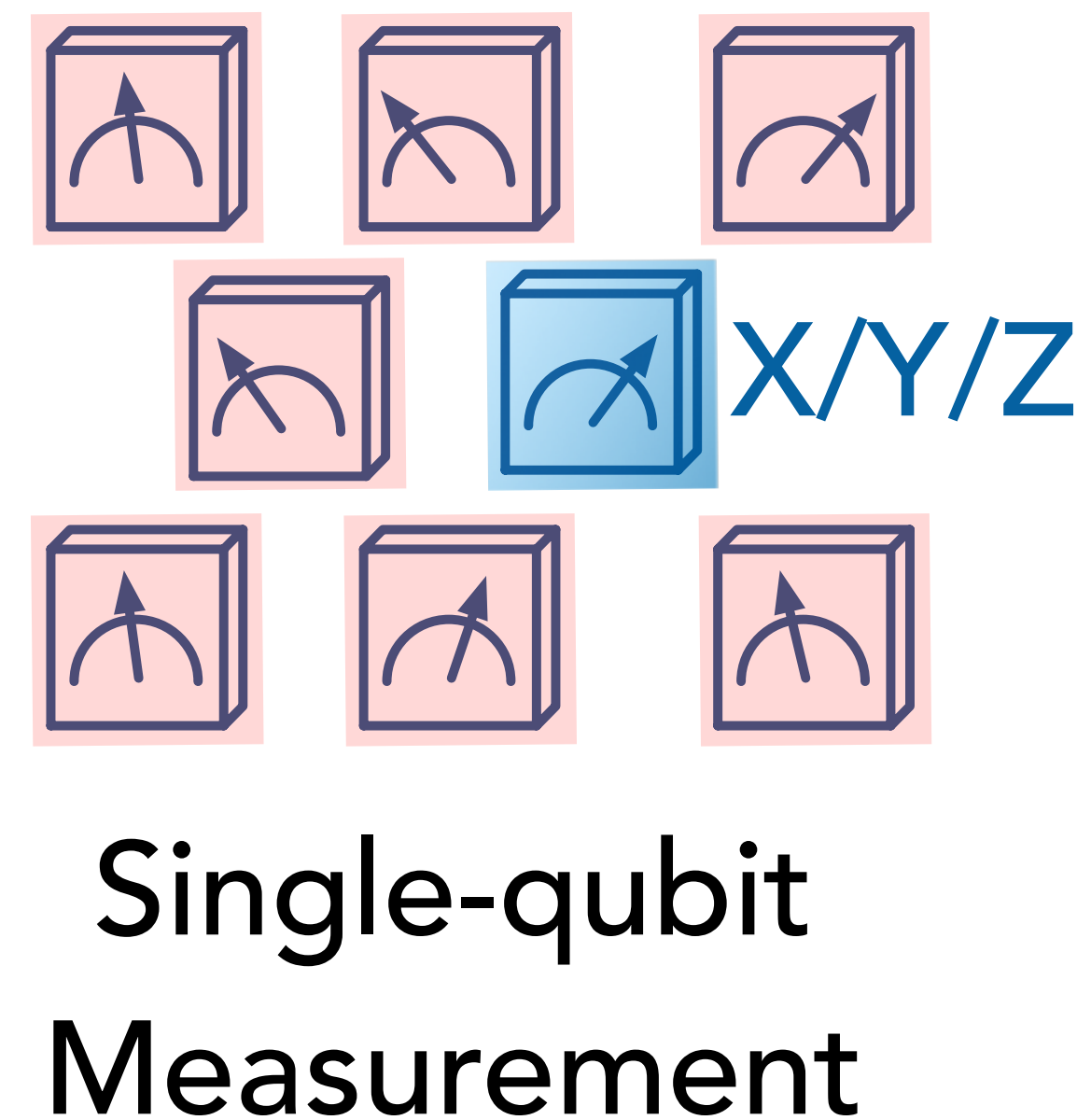
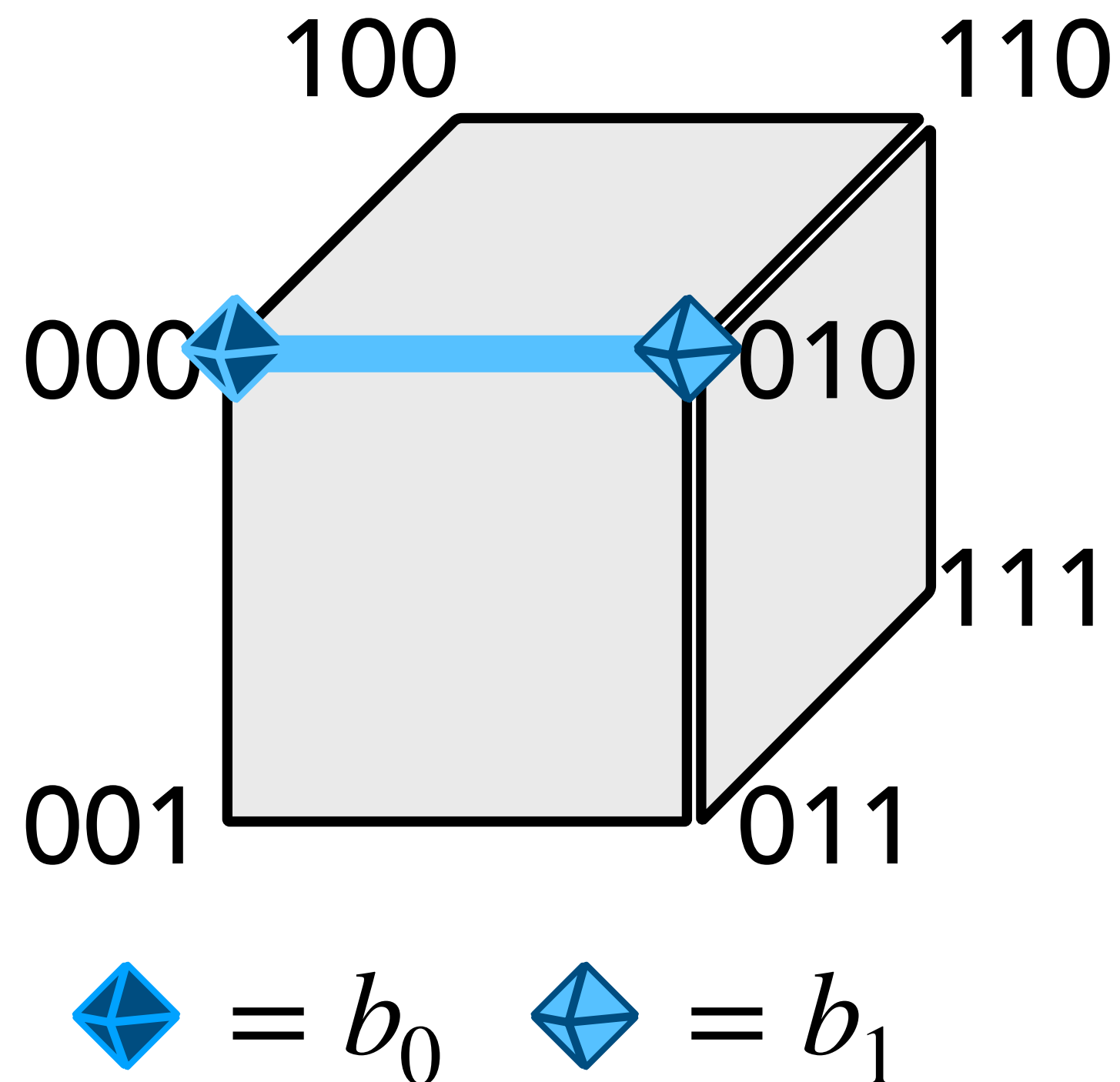

Postprocessing

- Use randomized Pauli measurement (classical shadow) on **qubit x** to predict the fidelity ω with the **ideal** 1-qubit state $|\psi_{b_0, b_1}\rangle$.

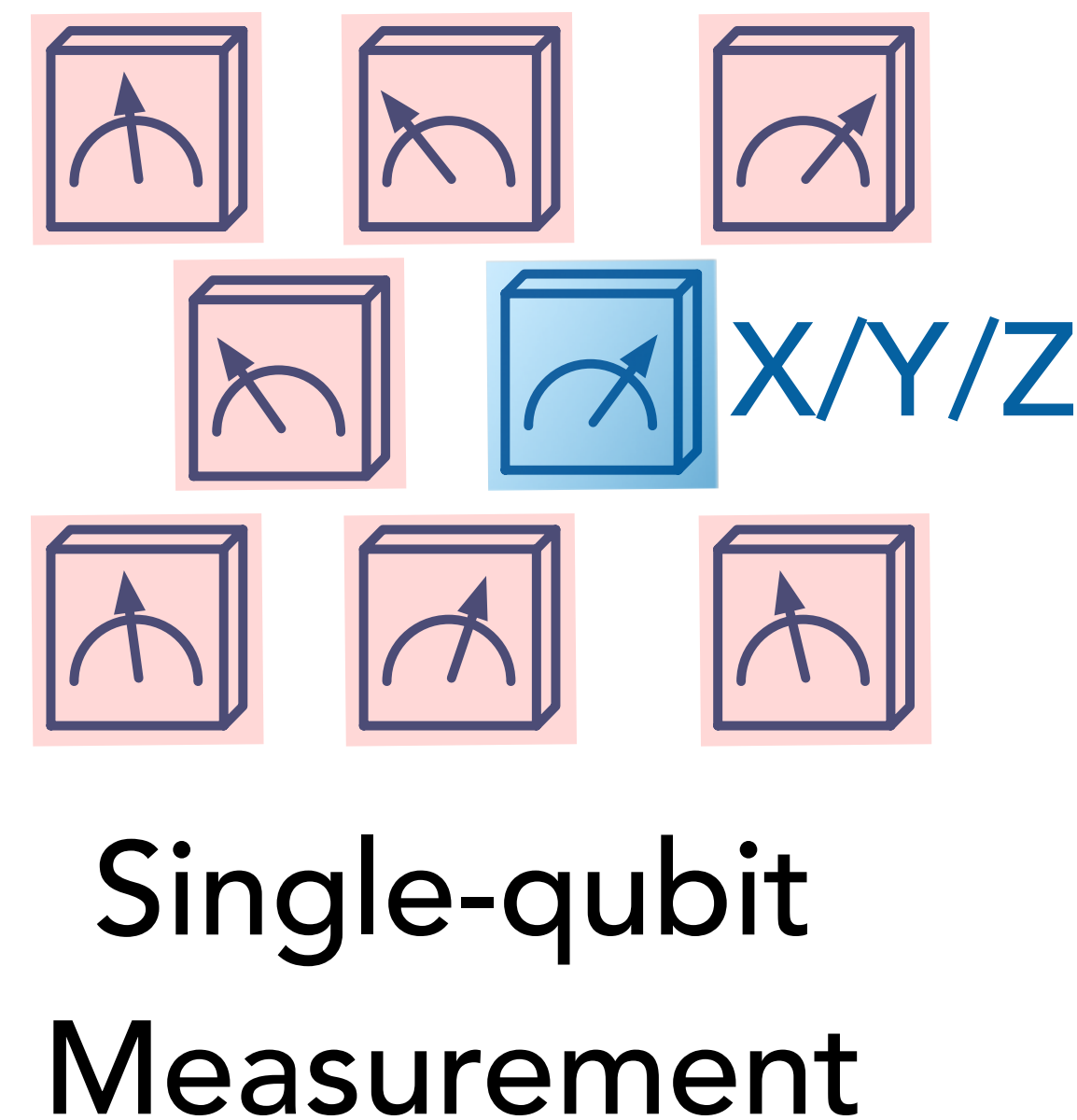
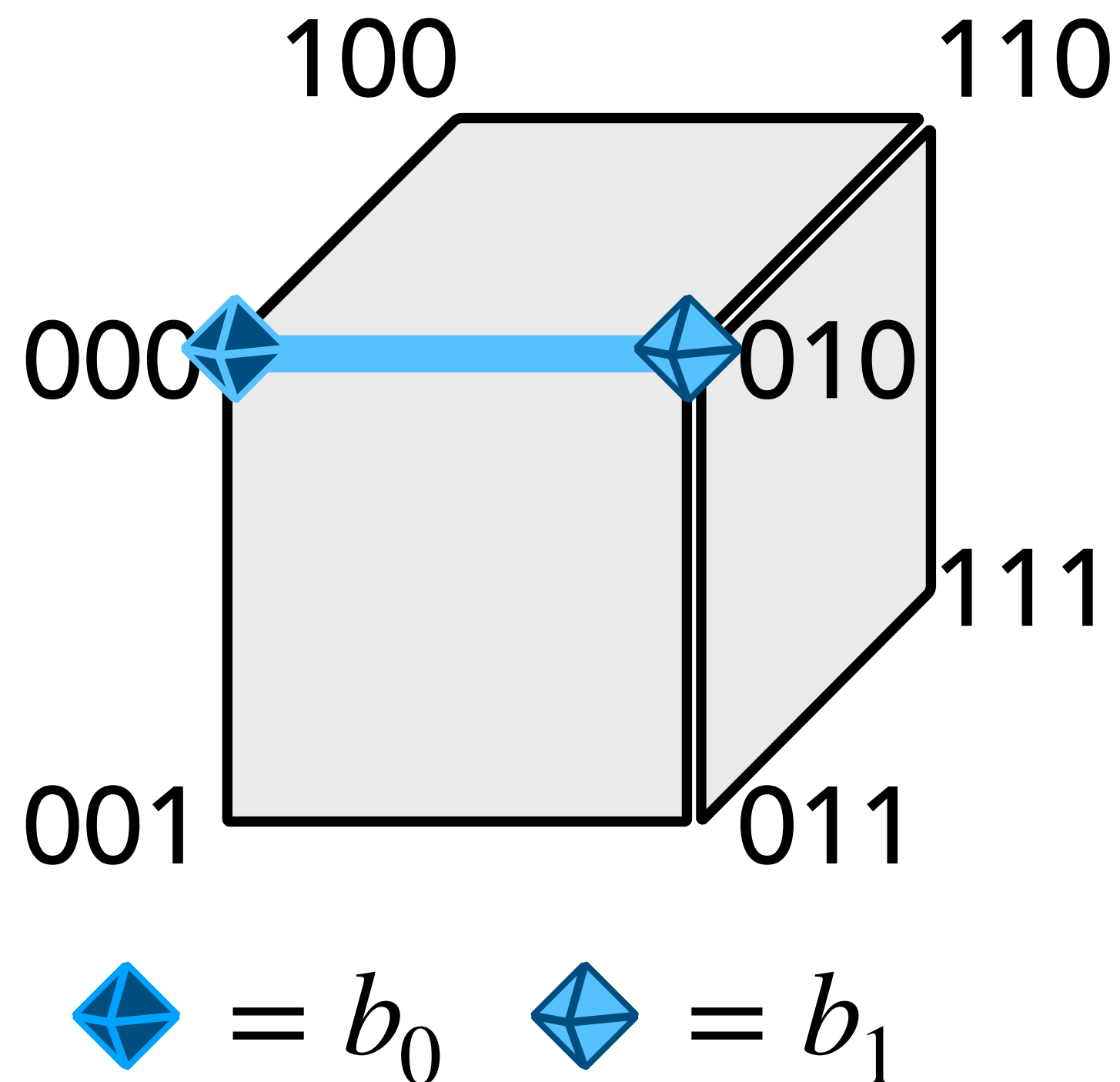

Postprocessing

- Use randomized Pauli measurement (classical shadow) on **qubit x** to predict the fidelity ω with the **ideal** 1-qubit state $|\psi_{b_0, b_1}\rangle$.

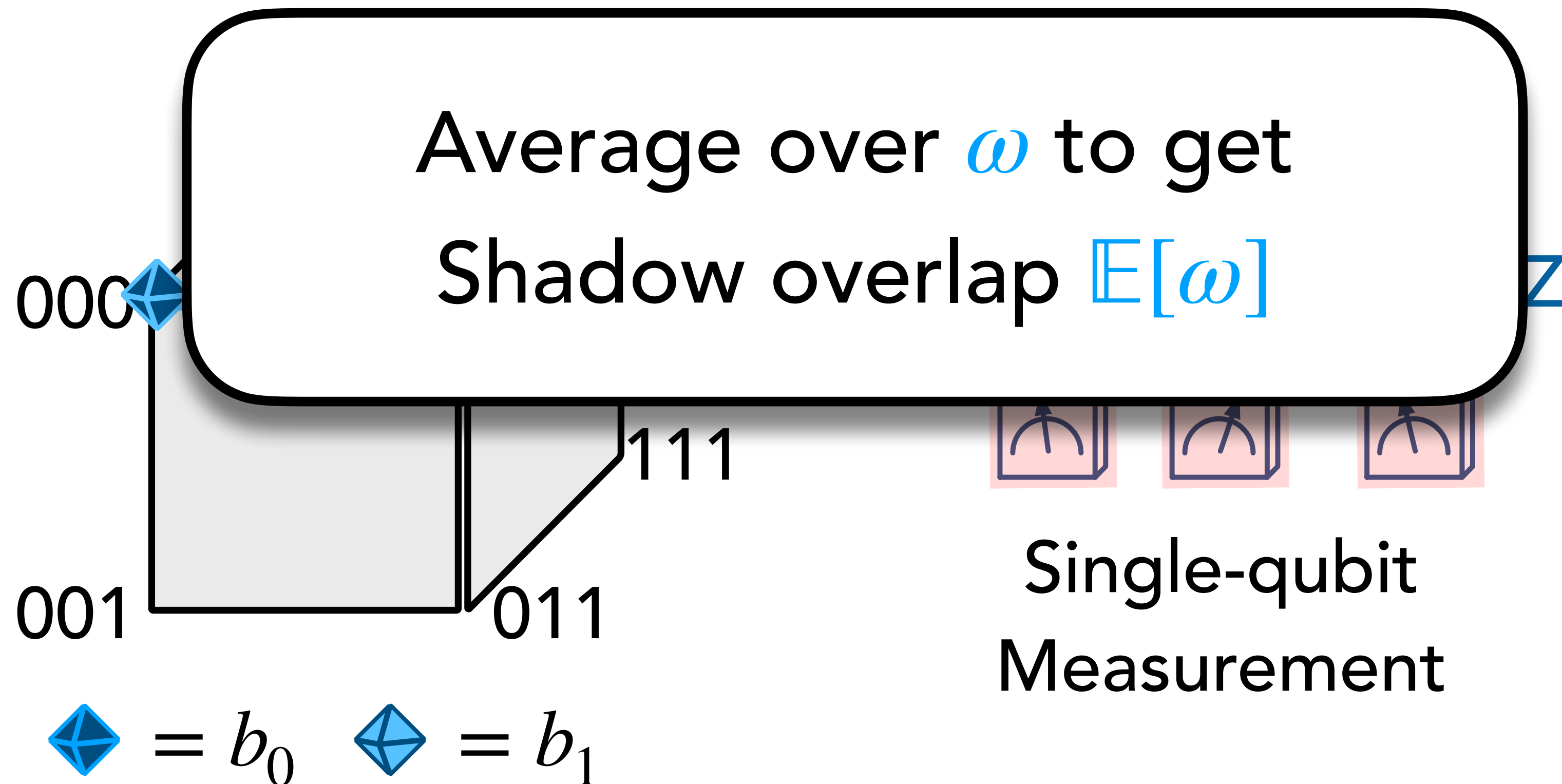

Key Feature

Shadow overlap $\mathbb{E}[\omega]$ accurately tracks the fidelity $\langle \psi | \rho | \psi \rangle$.

τ is the time the random walk takes to relax to stationary π

Key Feature

Shadow overlap $\mathbb{E}[\omega]$ accurately tracks the fidelity $\langle \psi | \rho | \psi \rangle$.

$$\mathbb{E}[\omega] \geq 1 - \epsilon \text{ implies } \langle \psi | \rho | \psi \rangle \geq 1 - \tau\epsilon$$

τ is the time the random walk takes to relax to stationary π

Key Feature

Shadow overlap $\mathbb{E}[\omega]$ accurately tracks the fidelity $\langle \psi | \rho | \psi \rangle$.

$$\mathbb{E}[\omega] \geq 1 - \epsilon \text{ implies } \langle \psi | \rho | \psi \rangle \geq 1 - \tau \epsilon$$

$$\langle \psi | \rho | \psi \rangle \geq 1 - \epsilon \text{ implies } \mathbb{E}[\omega] \geq 1 - \epsilon$$

τ is the time the random walk takes to relax to stationary π

Physical Intuition

Shadow overlap $\mathbb{E}[\omega]$ = $\frac{1}{n} \sum_{i=1}^n \sum_{b_{\neq i} \in \{0,1\}^{n-1}} \text{Tr} \left(\langle b_{\neq i} | \rho | b_{\neq i} \rangle \frac{\langle b_{\neq i} | \psi \chi \psi | b_{\neq i} \rangle}{\text{Tr} \langle b_{\neq i} | \psi \chi \psi | b_{\neq i} \rangle} \right)$

Physical Intuition

Shadow overlap $\mathbb{E}[\omega] = \frac{1}{n} \sum_{i=1}^n \sum_{b_{\neq i} \in \{0,1\}^{n-1}} \text{Tr} \left(\langle b_{\neq i} | \rho | b_{\neq i} \rangle \frac{\langle b_{\neq i} | \psi \rangle \langle \psi | b_{\neq i} \rangle}{\text{Tr} \langle b_{\neq i} | \psi \rangle \langle \psi | b_{\neq i} \rangle} \right)$

- $|+\dots+X+\dots+|$ and $|-\dots-X-\dots-|$ has fidelity 0.
- $|+\dots+X+\dots+|$ and $|-\dots-X-\dots-|$ has $\mathbb{E}[\omega]=0$.

Physical Intuition

Shadow overlap $\mathbb{E}[\omega] = \frac{1}{n} \sum_{i=1}^n \sum_{b_{\neq i} \in \{0,1\}^{n-1}} \text{Tr} \left(\langle b_{\neq i} | \rho | b_{\neq i} \rangle \frac{\langle b_{\neq i} | \psi \rangle \langle \psi | b_{\neq i} \rangle}{\text{Tr} \langle b_{\neq i} | \psi \rangle \langle \psi | b_{\neq i} \rangle} \right)$

● $| + \dots + X + \dots + |$ and $| + \dots + - X + \dots + - |$ has fidelity 0.

● $| + \dots + X + \dots + |$ and $| + \dots + - X + \dots + - |$ has $\mathbb{E}[\omega] = \frac{n-1}{n}$.

Physical Intuition

Shadow overlap $\mathbb{E}[\omega] = \frac{1}{n} \sum_{i=1}^n \sum_{b_{\neq i} \in \{0,1\}^{n-1}} \text{Tr} \left(\langle b_{\neq i} | \rho | b_{\neq i} \rangle \frac{\langle b_{\neq i} | \psi \rangle \langle \psi | b_{\neq i} \rangle}{\text{Tr} \langle b_{\neq i} | \psi \rangle \langle \psi | b_{\neq i} \rangle} \right)$

- $| + \dots + X + \dots + |$ and $| + \dots + - X + \dots + - |$ has fidelity 0.
- $| + \dots + X + \dots + |$ and $| + \dots + - X + \dots + - |$ has $\mathbb{E}[\omega] = \frac{n-1}{n}$.
- Shadow overlap has a Hamming distance nature.

Outline

- Theorem
- Protocol
- Applications



Outline

- Theorem
- Protocol
- Applications



Applications

What can we use this new certification protocol for?

Applications

What can we use this new certification protocol for?

Example 1

Benchmarking

Shadow overlap $\mathbb{E}[\omega]$ certifies
if the state has a high fidelity

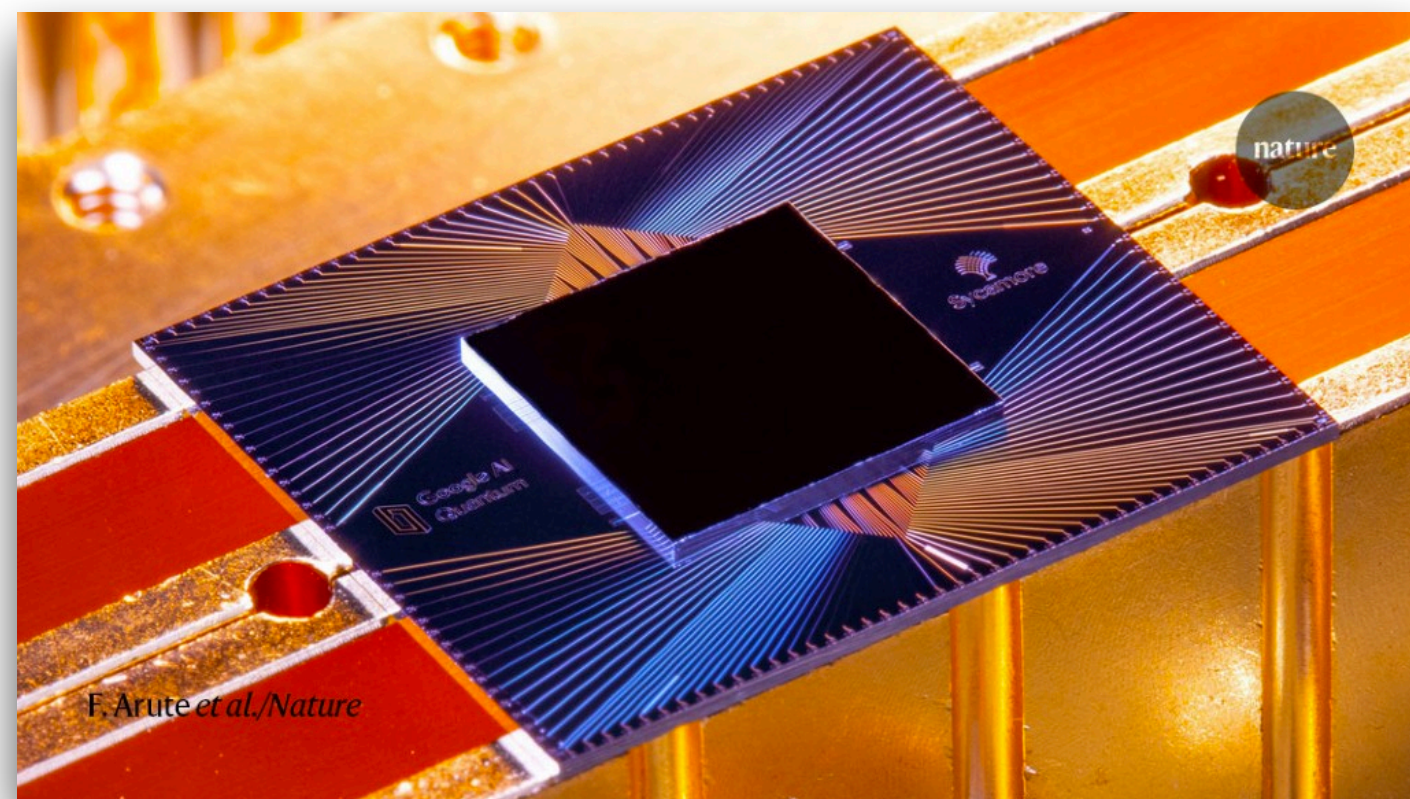

Benchmarking quantum devices

4-qubit Haar random state
White Noise

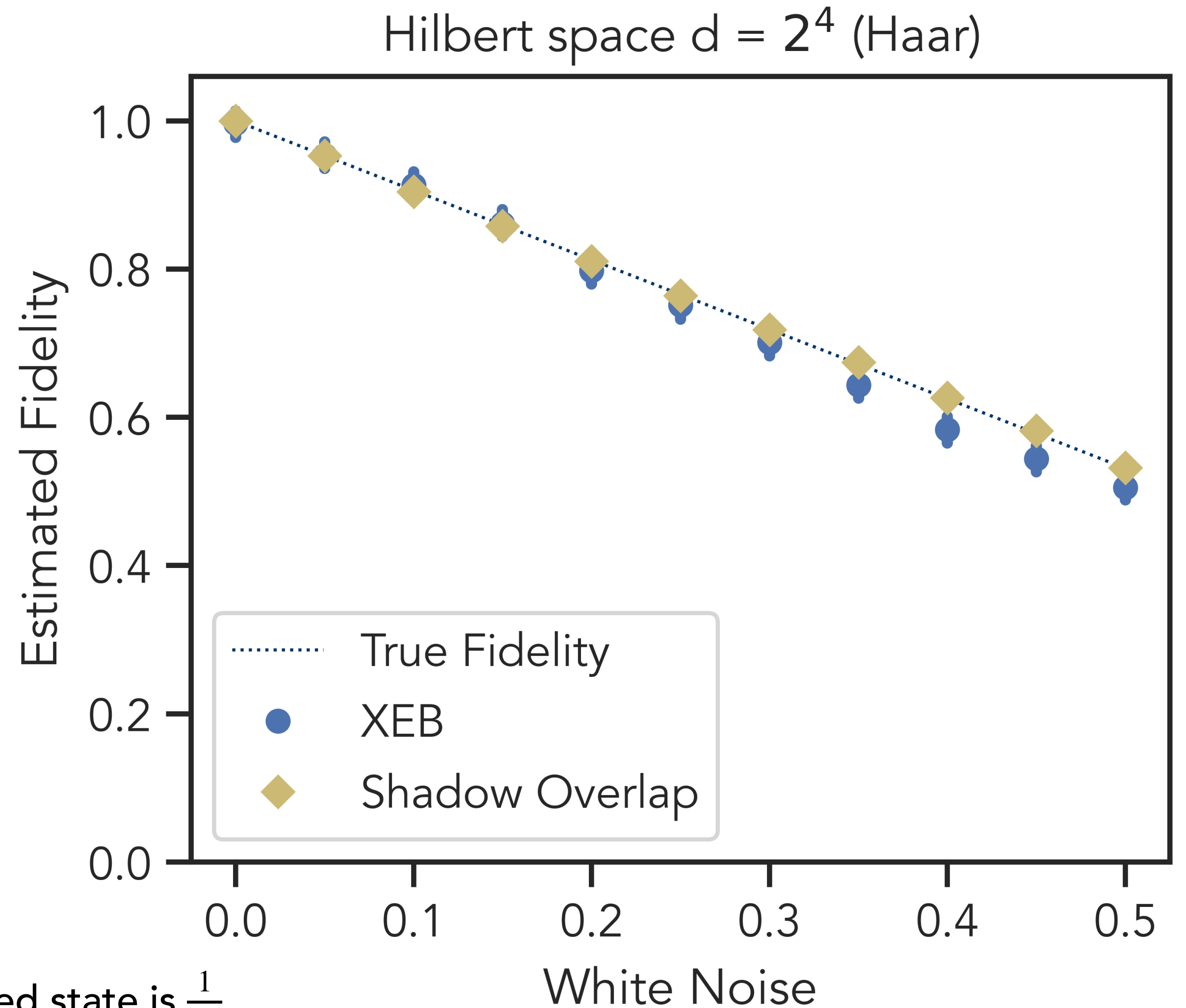

*Shadow overlap normalized s.t., target state is 1, maximally mixed state is $\frac{1}{2^n}$

Benchmarking quantum devices

20-qubit Haar random state
White Noise

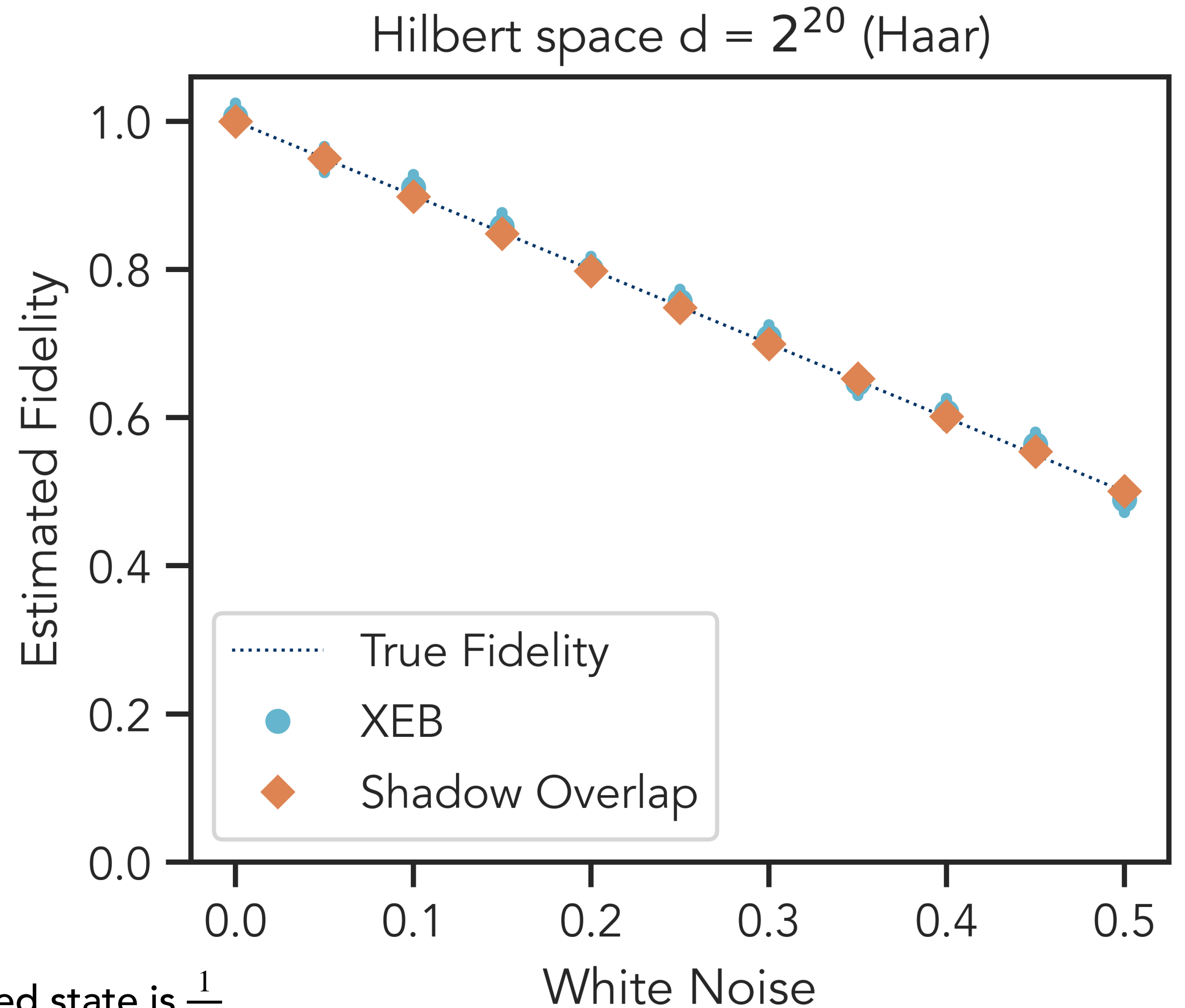

*Shadow overlap normalized s.t., target state is 1, maximally mixed state is $\frac{1}{2^n}$

Benchmarking quantum devices

4-qubit Haar random state
Coherent Noise

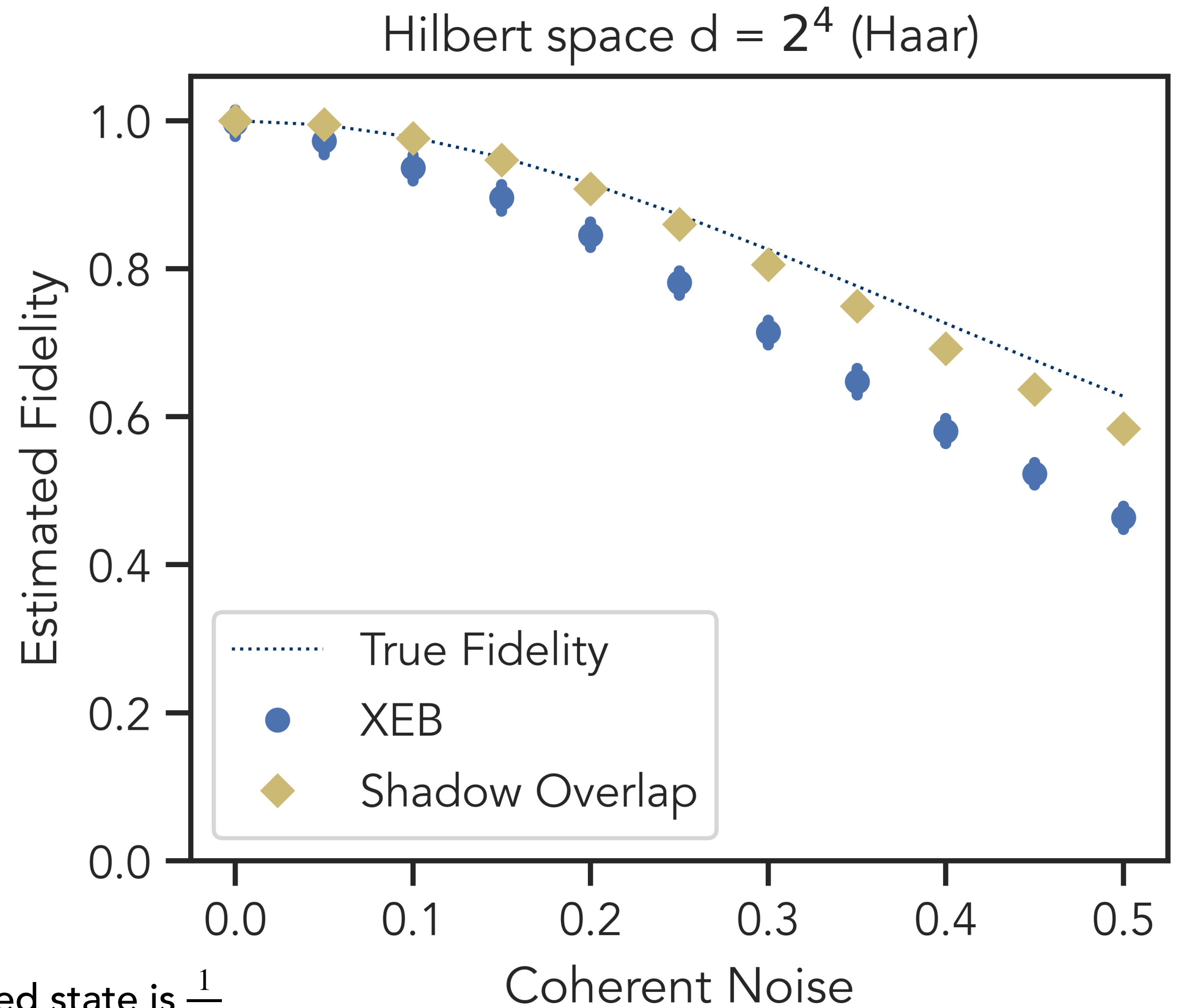

*Shadow overlap normalized s.t., target state is 1, maximally mixed state is $\frac{1}{2^n}$

Benchmarking quantum devices

20-qubit Haar random state
Coherent Noise

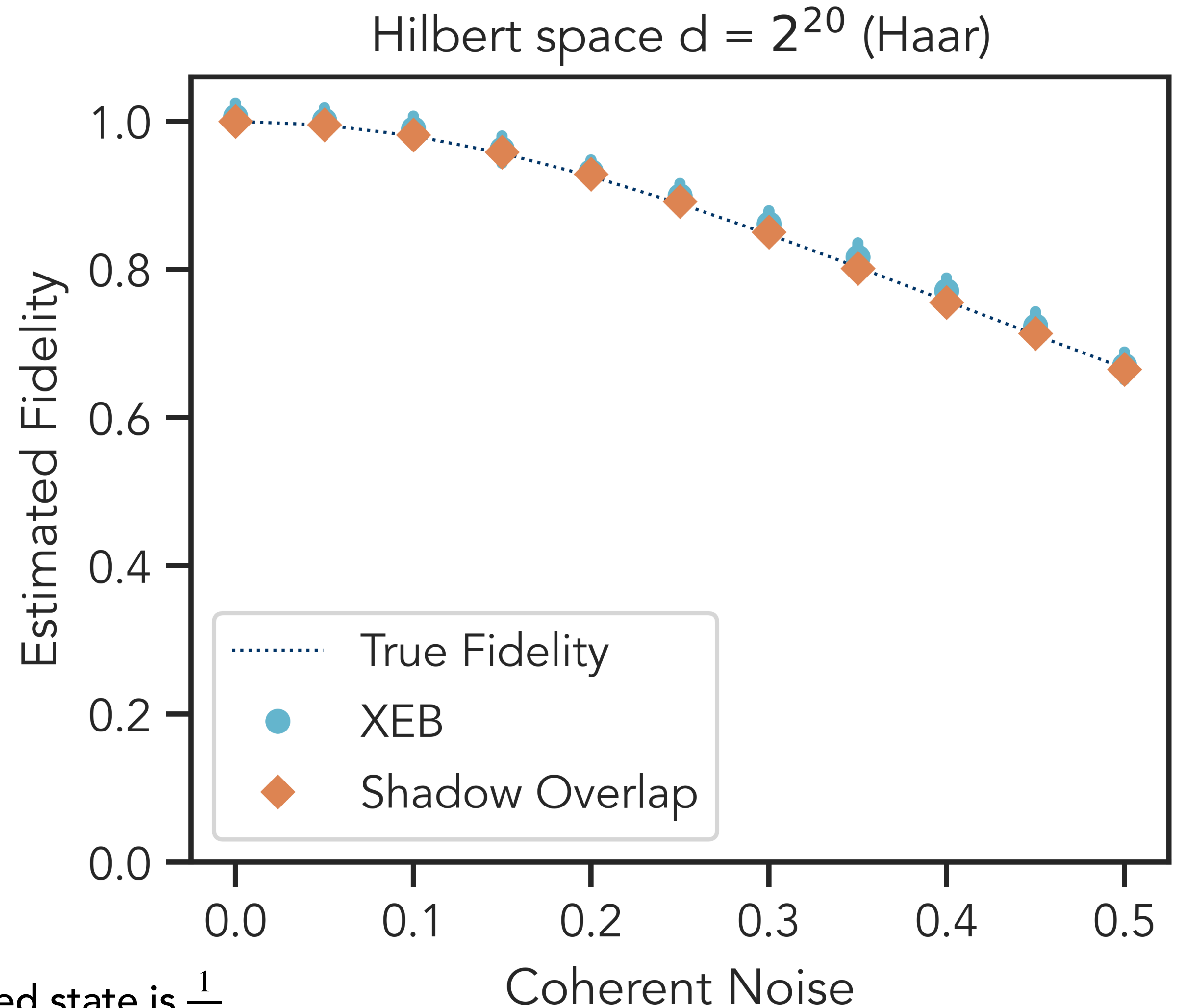

*Shadow overlap normalized s.t., target state is 1, maximally mixed state is $\frac{1}{2^n}$

Benchmarking quantum devices

4-qubit random structured state
White Noise

$$|\psi\rangle = U_{\text{phase}} \bigotimes_{i=1}^4 |\psi_i\rangle$$

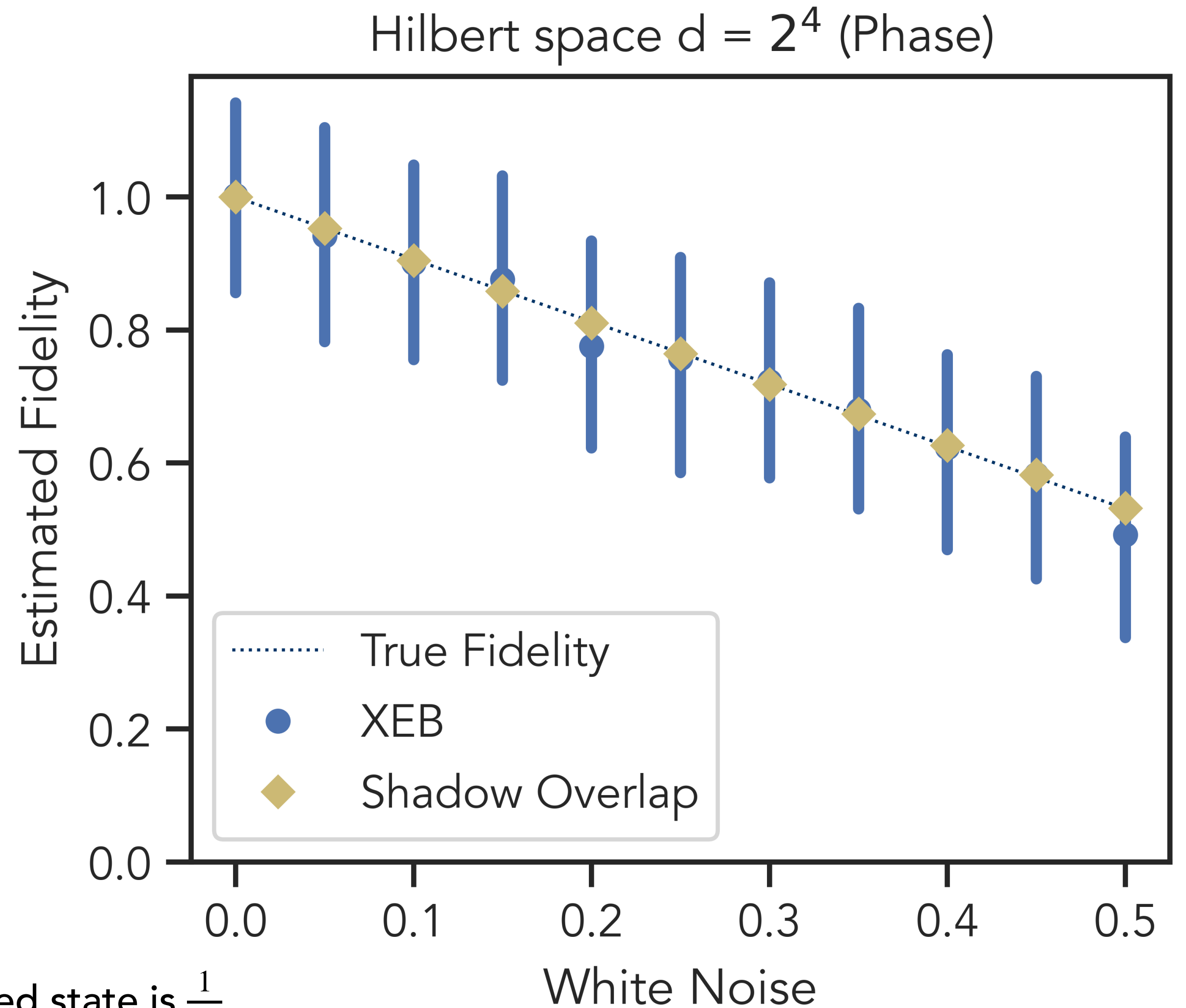

*Shadow overlap normalized s.t., target state is 1, maximally mixed state is $\frac{1}{2^n}$

Benchmarking quantum devices

20-qubit random structured state
White Noise

$$|\psi\rangle = U_{\text{phase}} \bigotimes_{i=1}^{20} |\psi_i\rangle$$

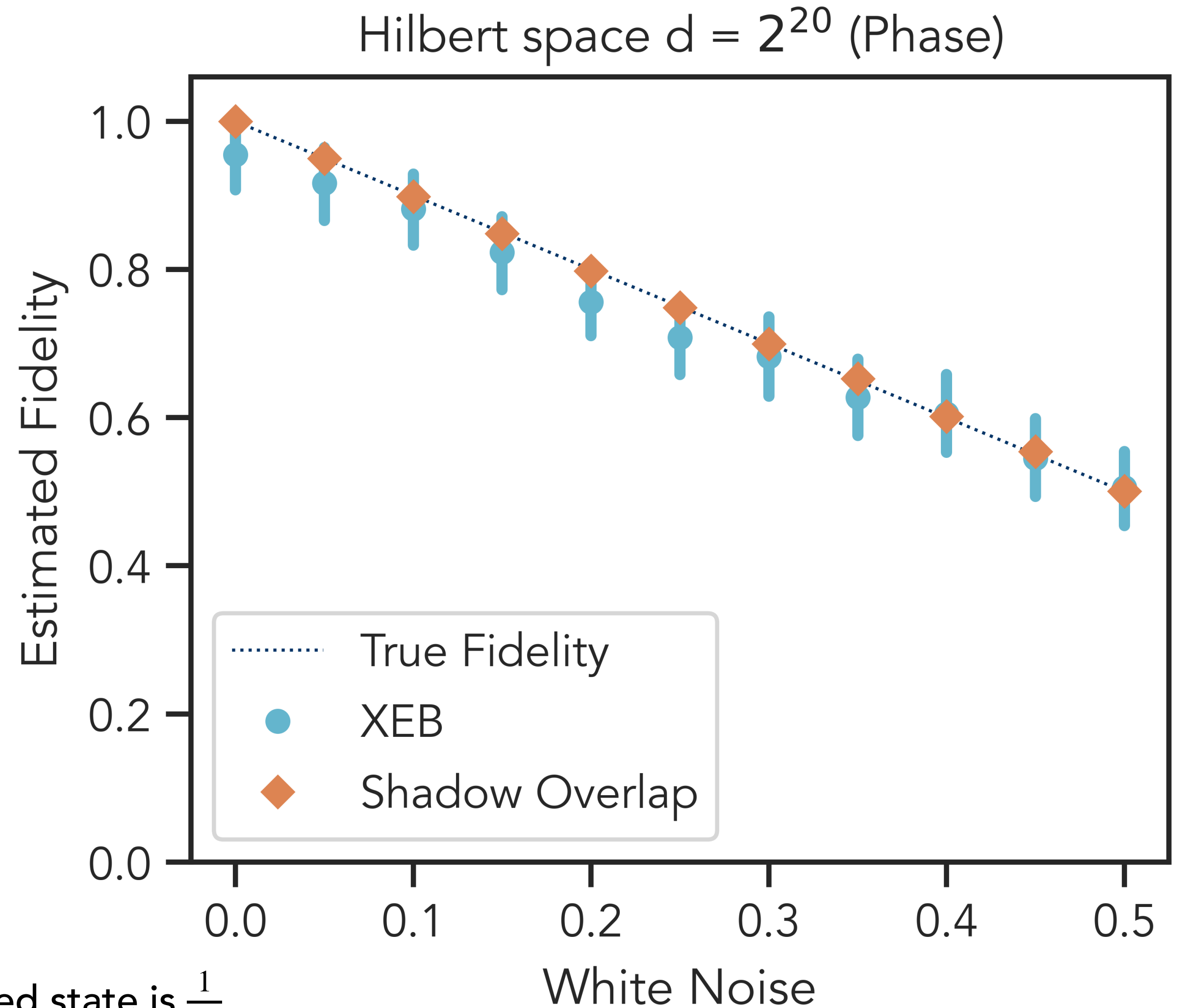

*Shadow overlap normalized s.t., target state is 1, maximally mixed state is $\frac{1}{2^n}$

Benchmarking quantum devices

4-qubit random structured state
Coherent Noise

$$|\psi\rangle = U_{\text{phase}} \bigotimes_{i=1}^4 |\psi_i\rangle$$

Hilbert space $d = 2^4$ (Phase)

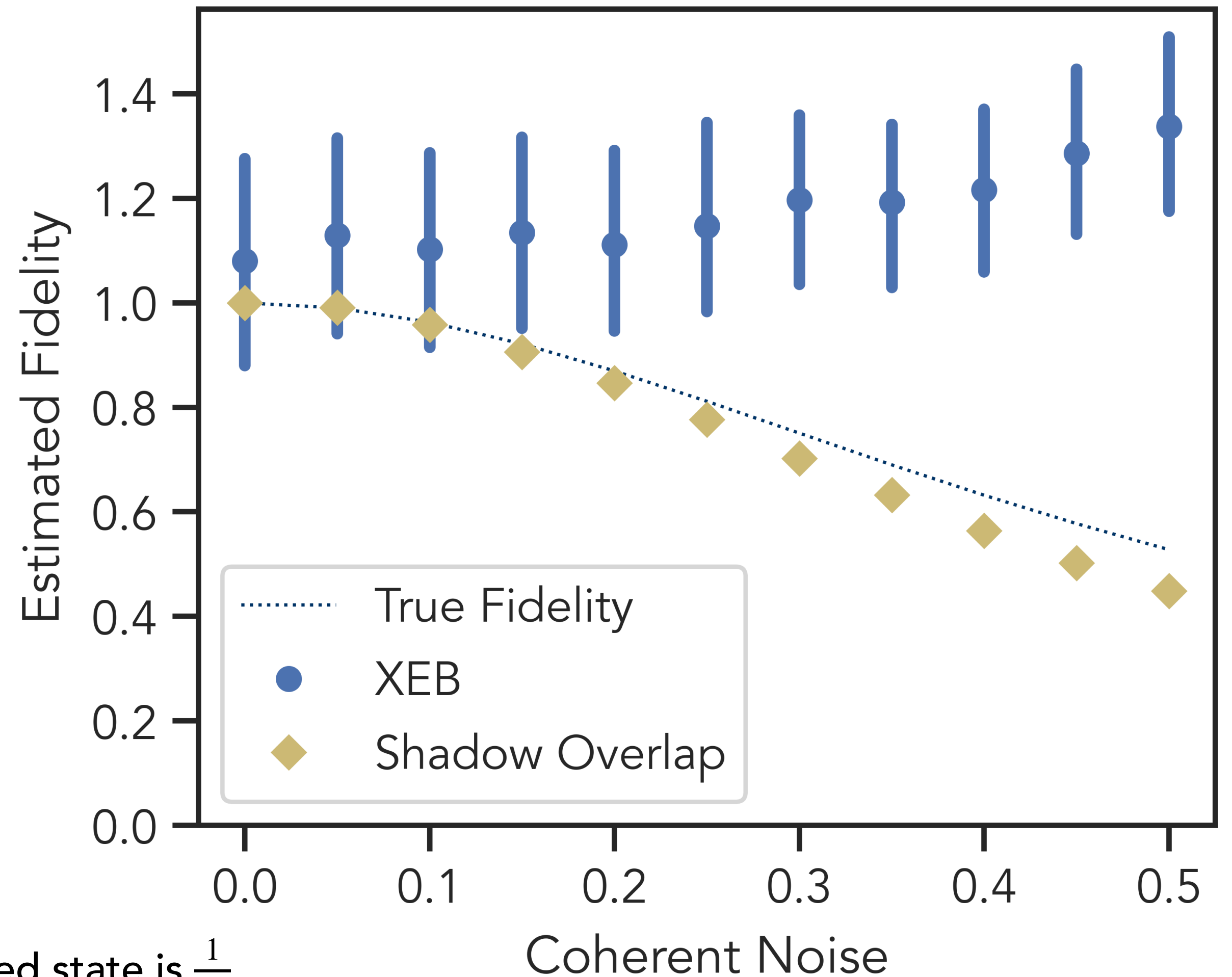

*Shadow overlap normalized s.t., target state is 1, maximally mixed state is $\frac{1}{2^n}$

Benchmarking quantum devices

20-qubit random structured state
Coherent Noise

$$|\psi\rangle = U_{\text{phase}} \bigotimes_{i=1}^{20} |\psi_i\rangle$$

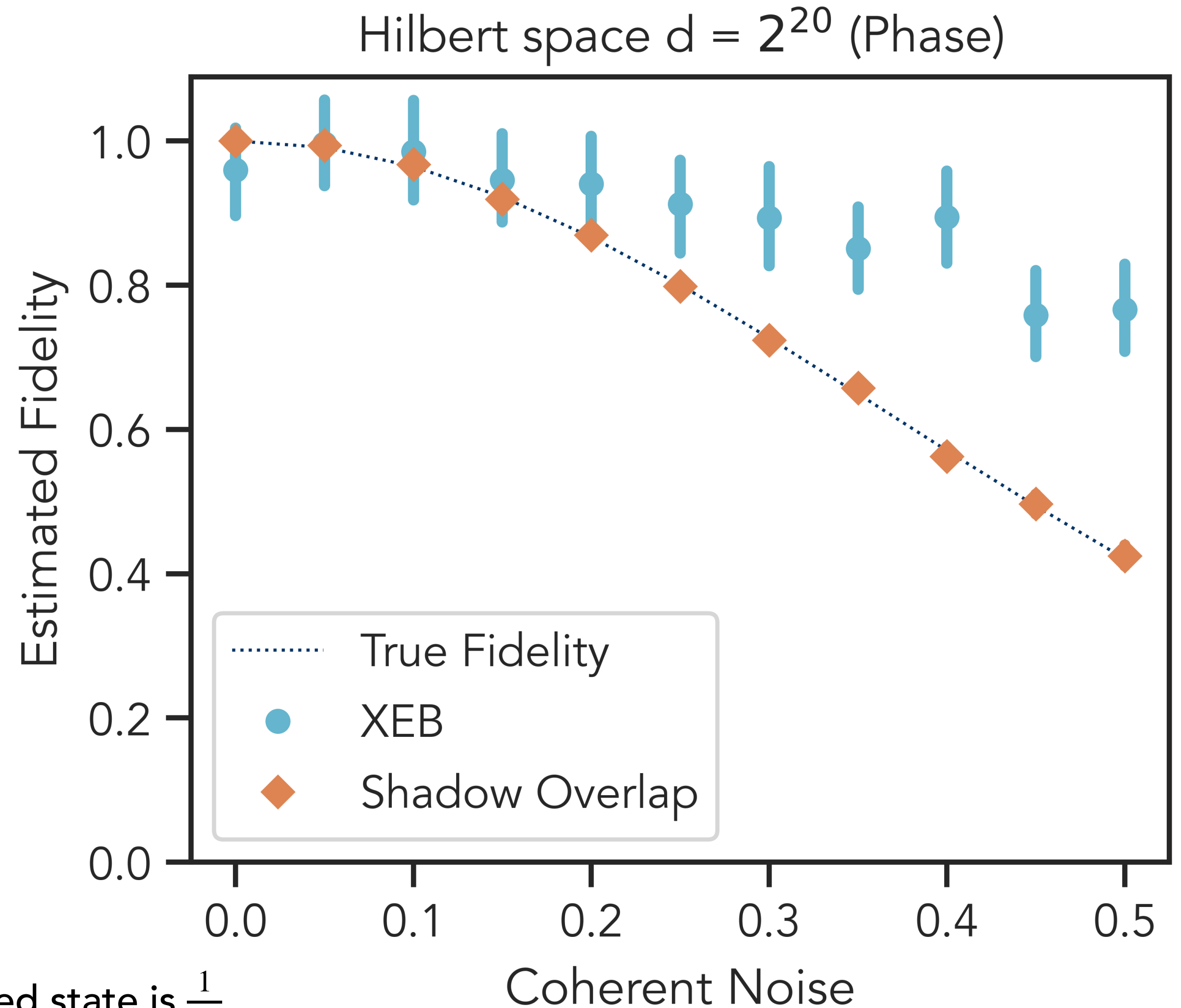

*Shadow overlap normalized s.t., target state is 1, maximally mixed state is $\frac{1}{2^n}$

Applications

What can we use this new certification protocol for?

Example 1

Benchmarking

Shadow overlap $\mathbb{E}[\omega]$ certifies
if the state has a high fidelity

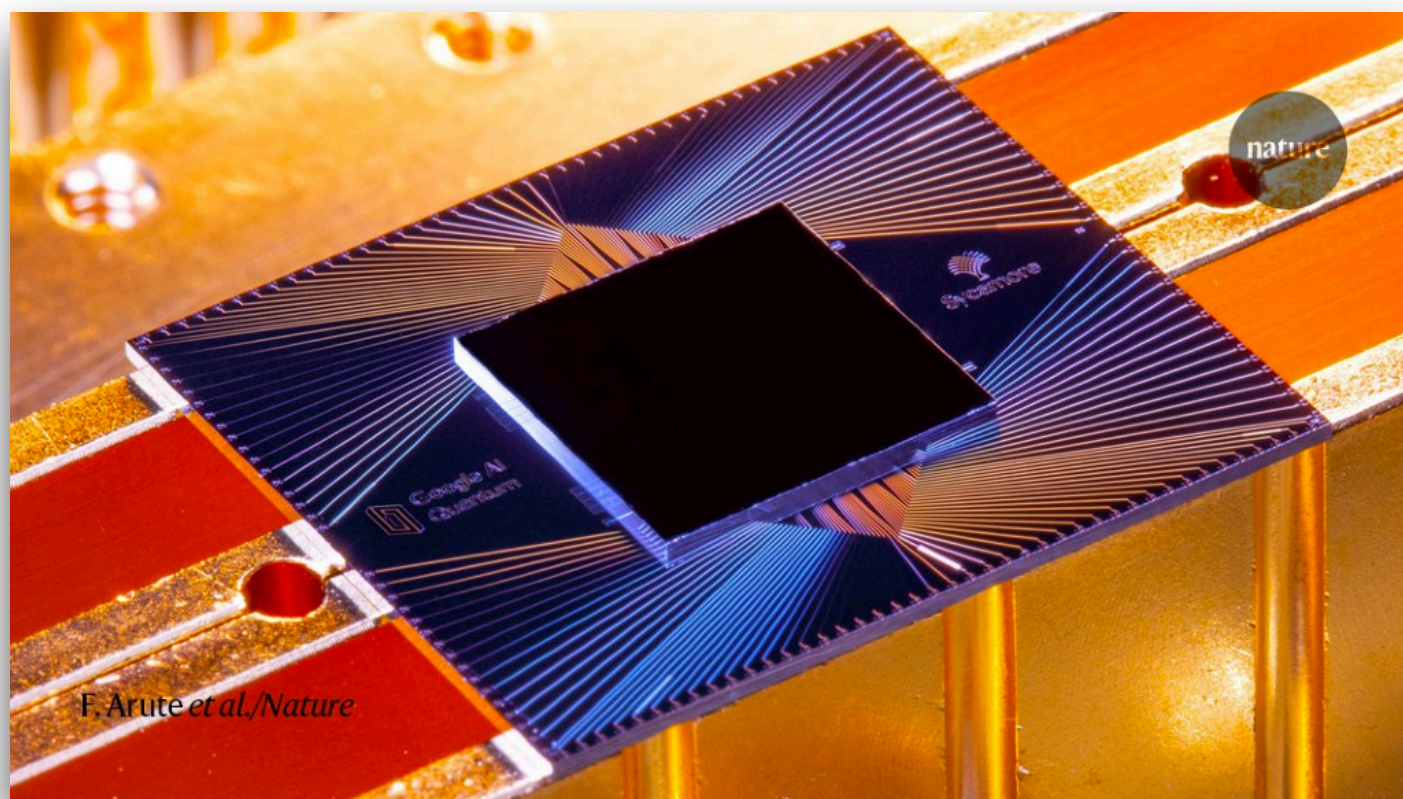

Applications

What can we use this new certification protocol for?

Example 1

Benchmarking

Shadow overlap $\mathbb{E}[\omega]$ certifies if the state has a high fidelity

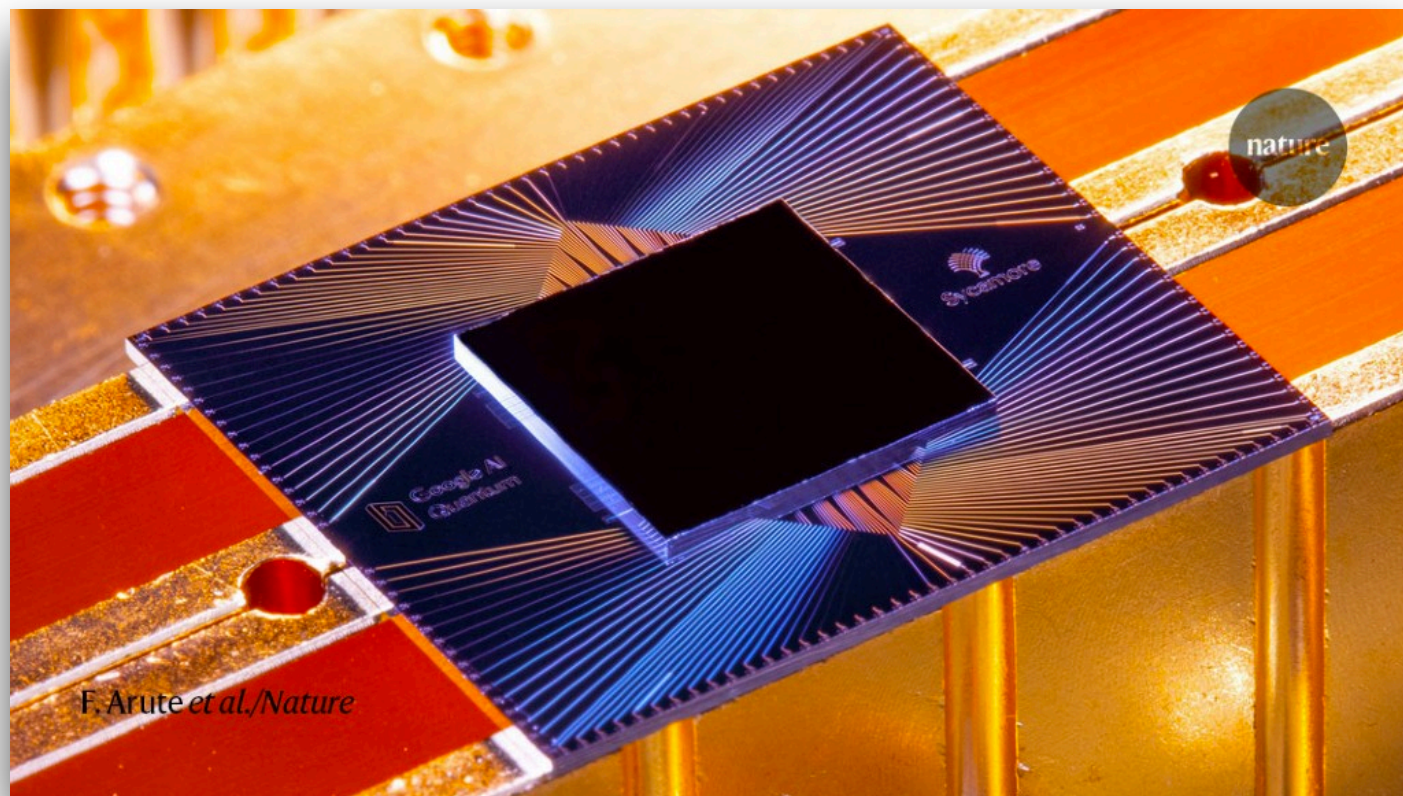

Example 2

ML tomography

Train/certify ML models, such as neural quantum states, using shadow overlap $\mathbb{E}[\omega]$

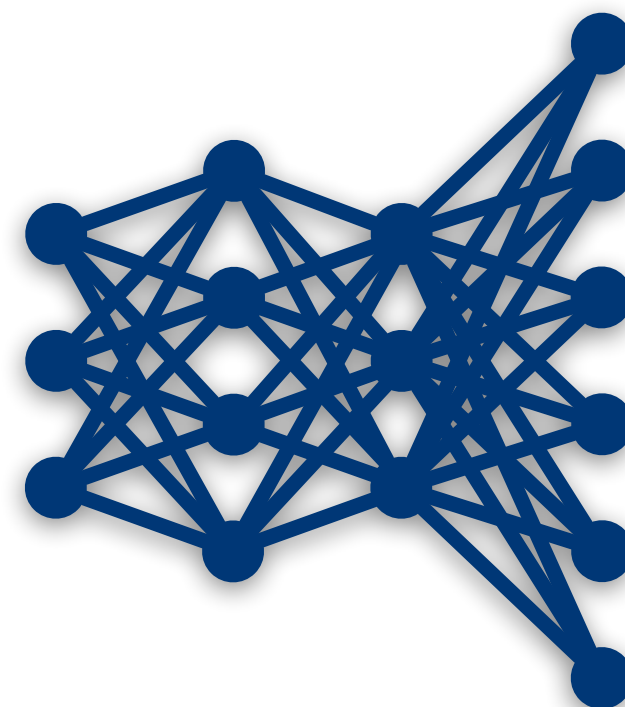

Training/Certifying NN tomography

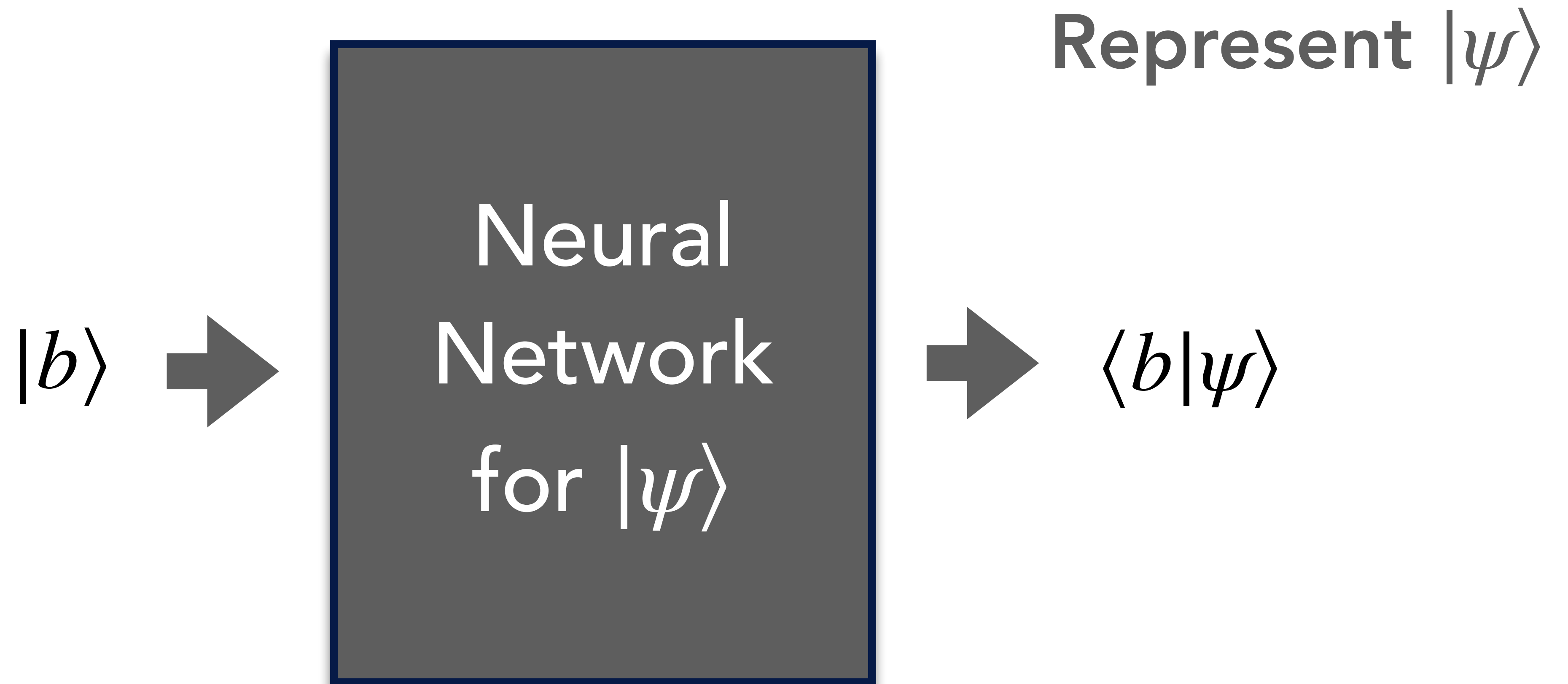

Standard Neural Quantum State

Training/Certifying NN tomography

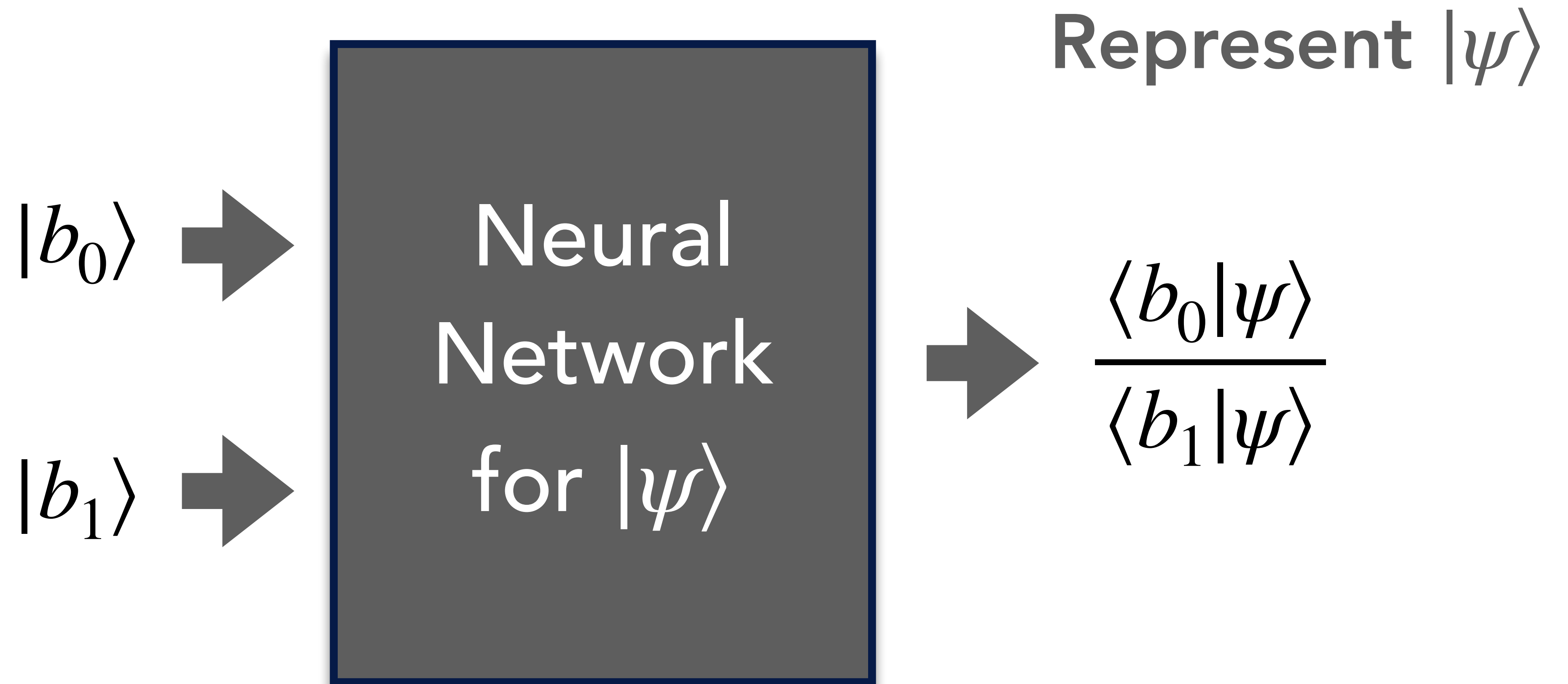

Relative Neural Quantum State

Training/Certifying NN tomography

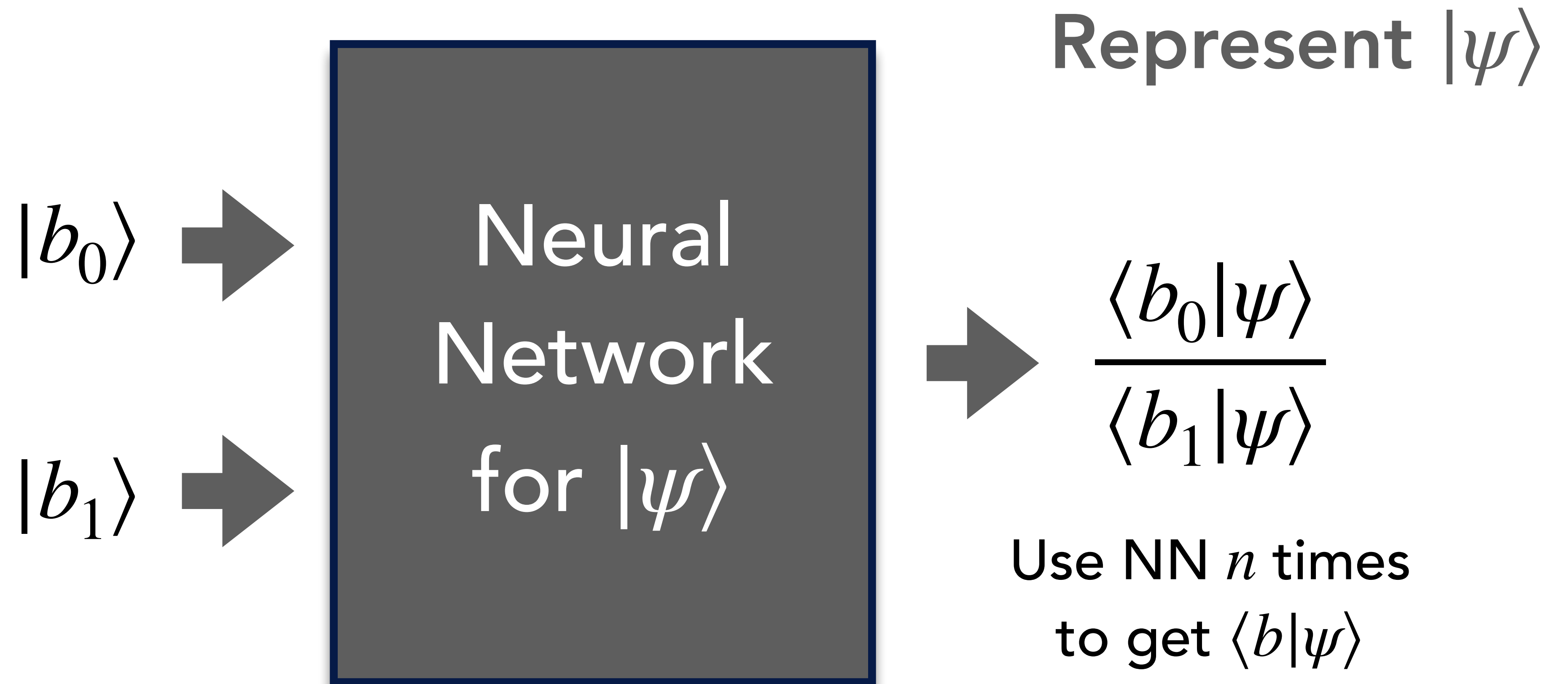

Relative Neural Quantum State

Training/Certifying NN tomography

We consider learning a class of 120-qubit states with exponentially high circuit complexity.

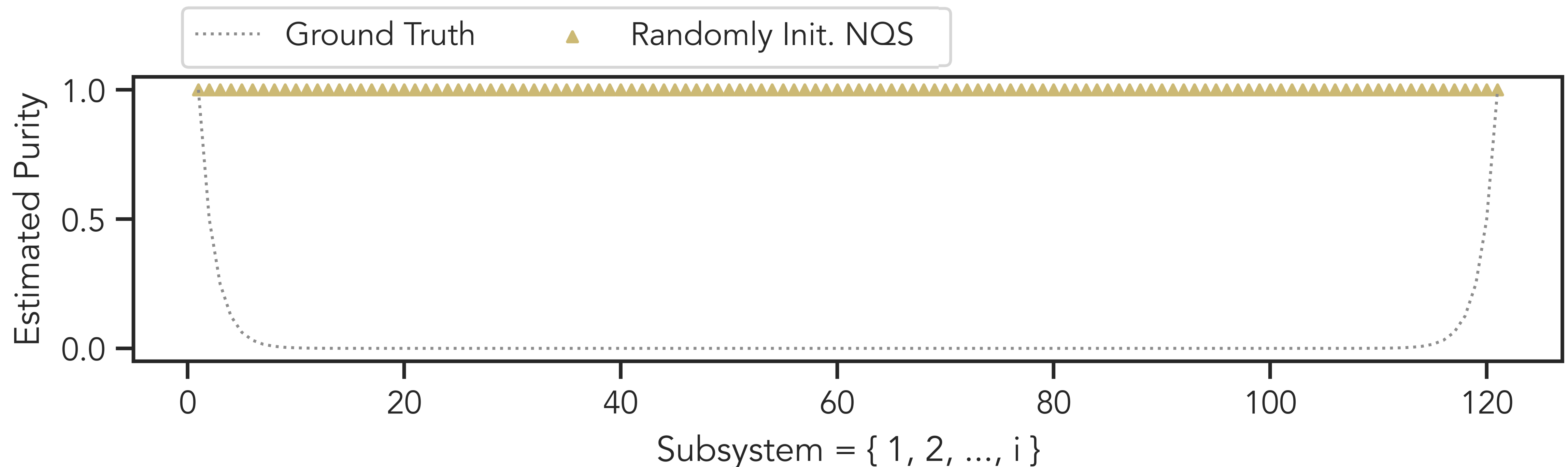

Training/Certifying NN tomography

Trained using
shadow-overlap-based loss

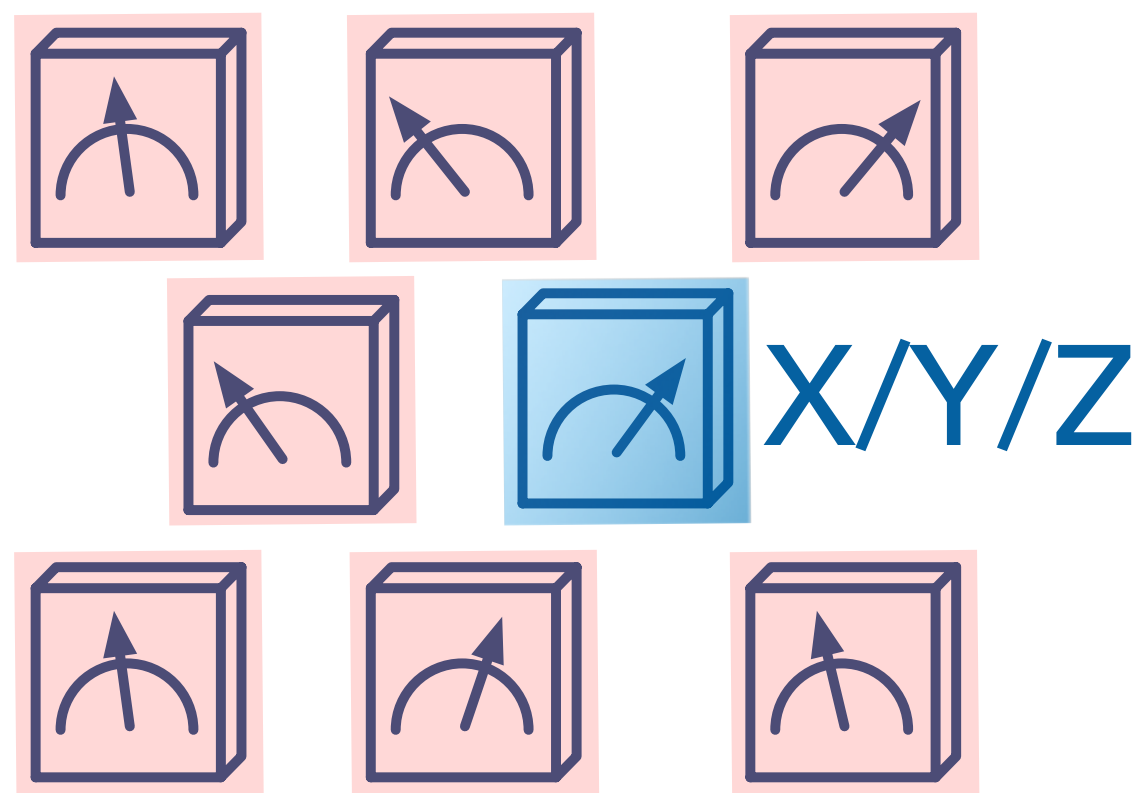

Certified using
shadow overlap

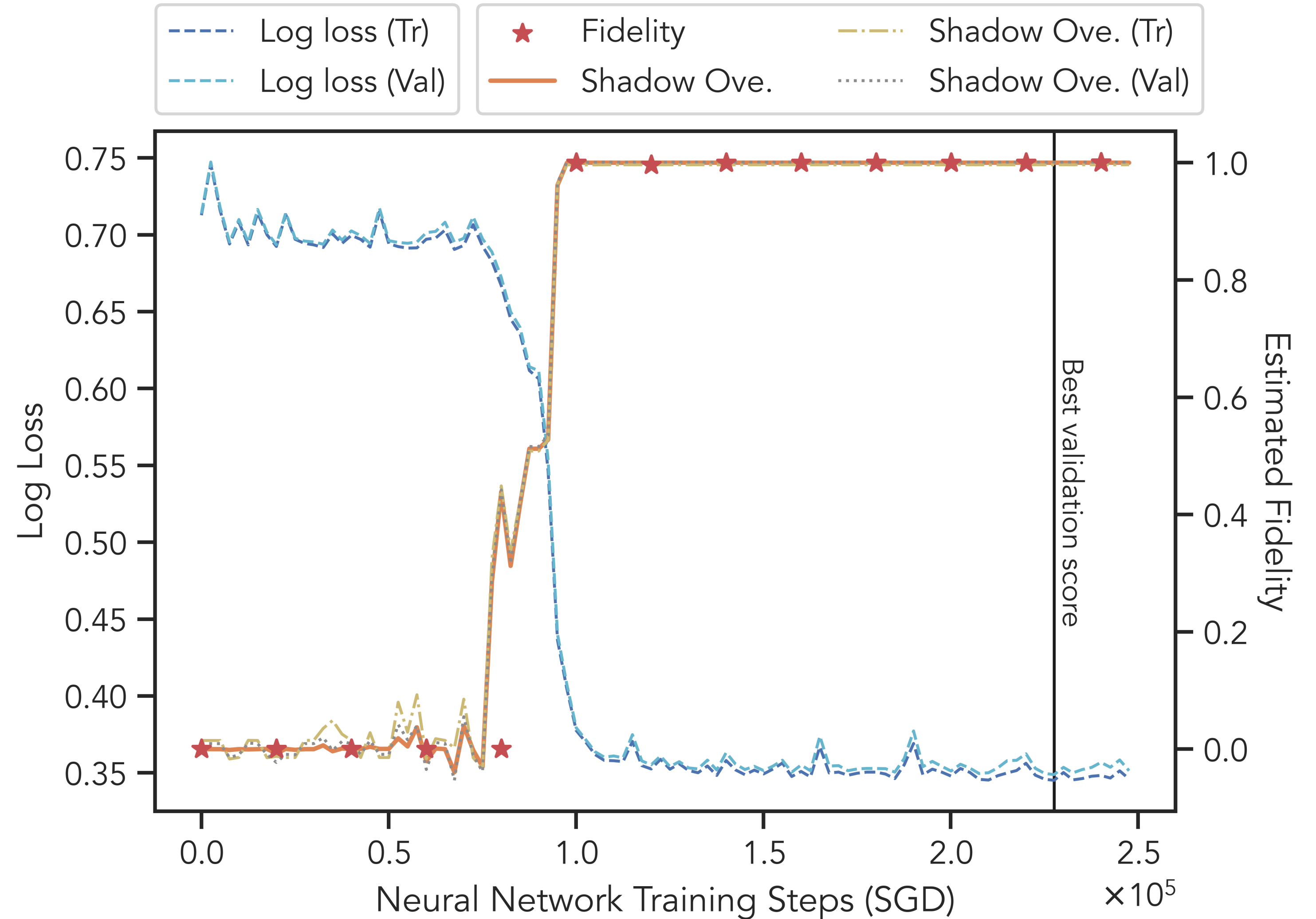

Training/Certifying NN tomography

We consider learning a class of 120-qubit states with exponentially high circuit complexity.

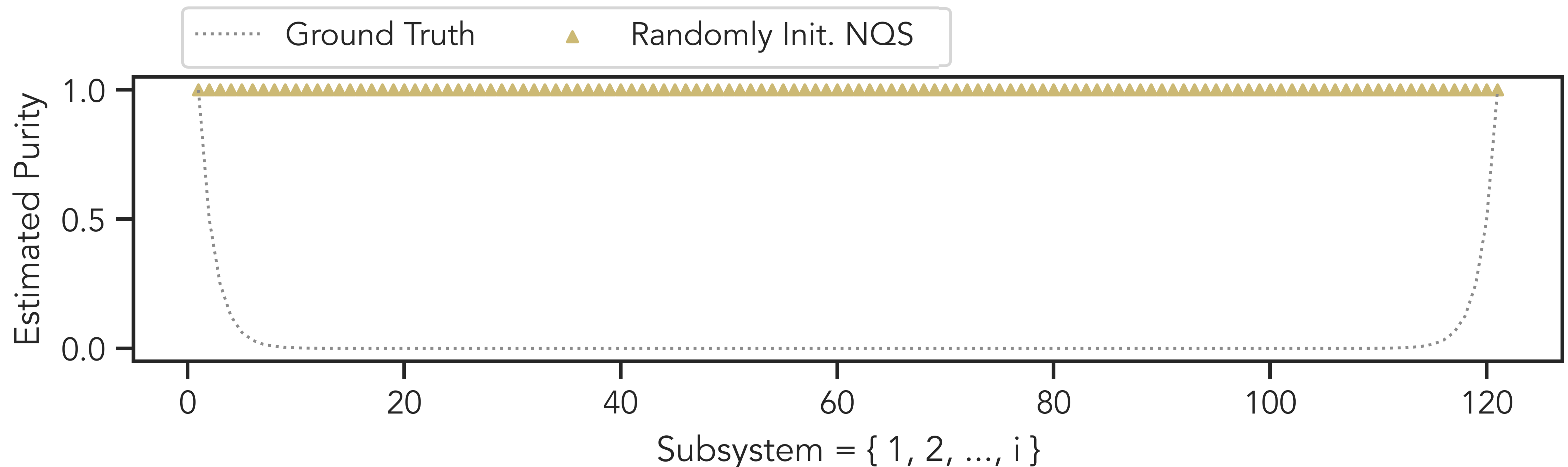

Training/Certifying NN tomography

We consider learning a class of 120-qubit states with exponentially high circuit complexity.

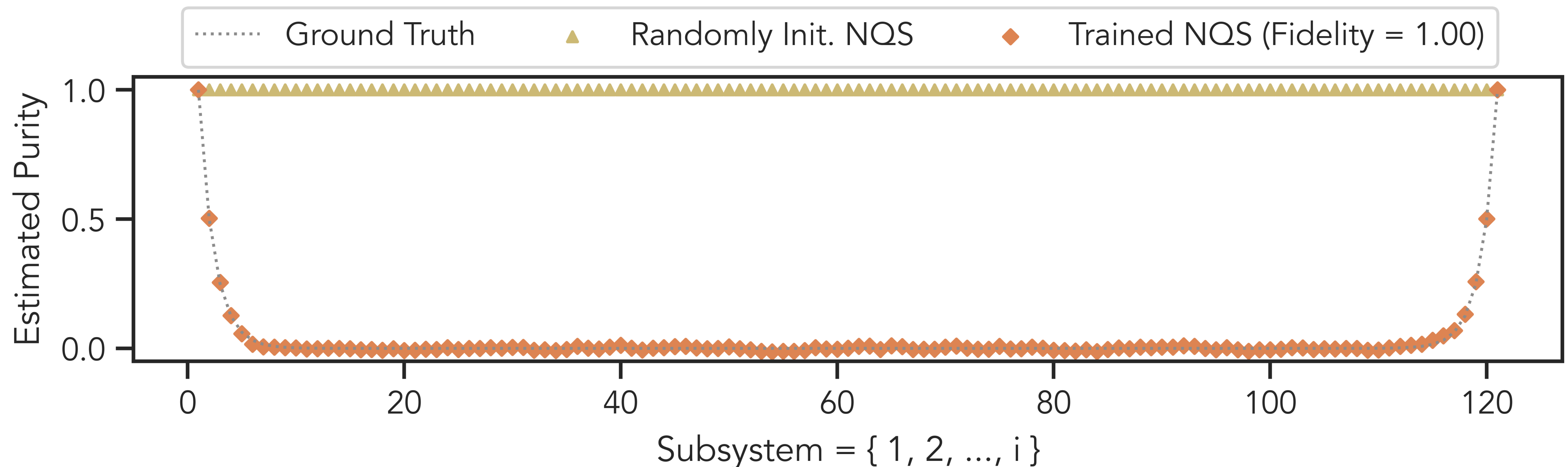

Applications

What can we use this new certification protocol for?

Example 1

Benchmarking

Shadow overlap $\mathbb{E}[\omega]$ certifies if the state has a high fidelity

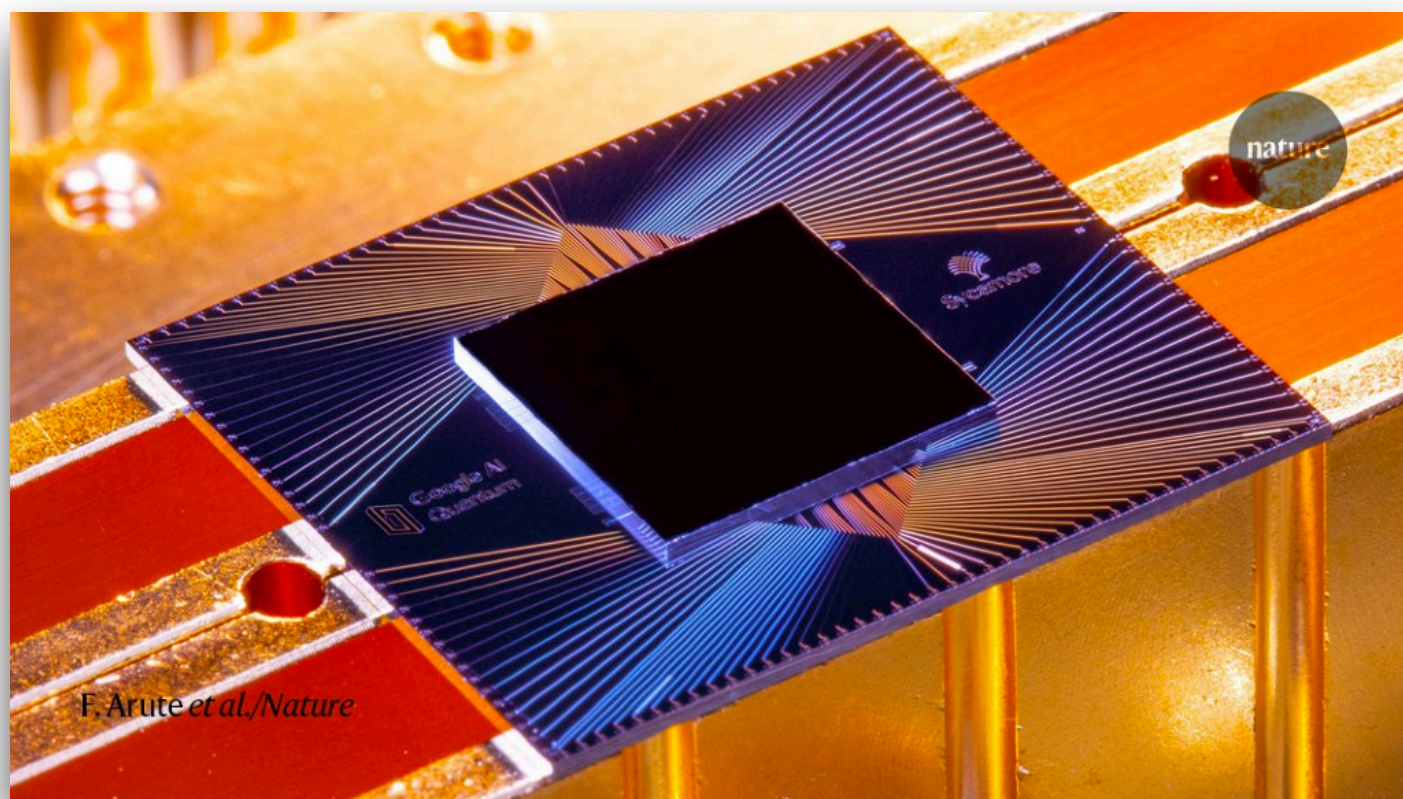

Example 2

ML tomography

Train/certify ML models, such as neural quantum states, using shadow overlap $\mathbb{E}[\omega]$

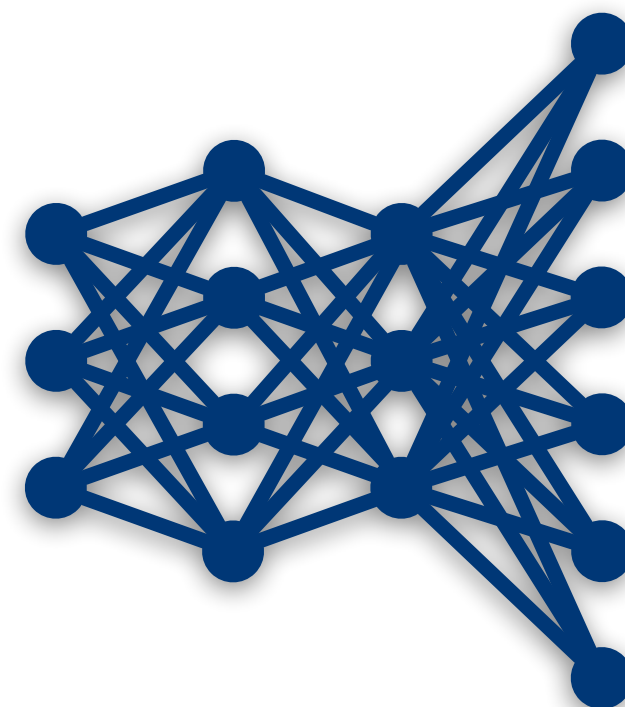

Applications

What can we use this new certification protocol for?

Example 1

Benchmarking

Shadow overlap $\mathbb{E}[\omega]$ certifies if the state has a high fidelity

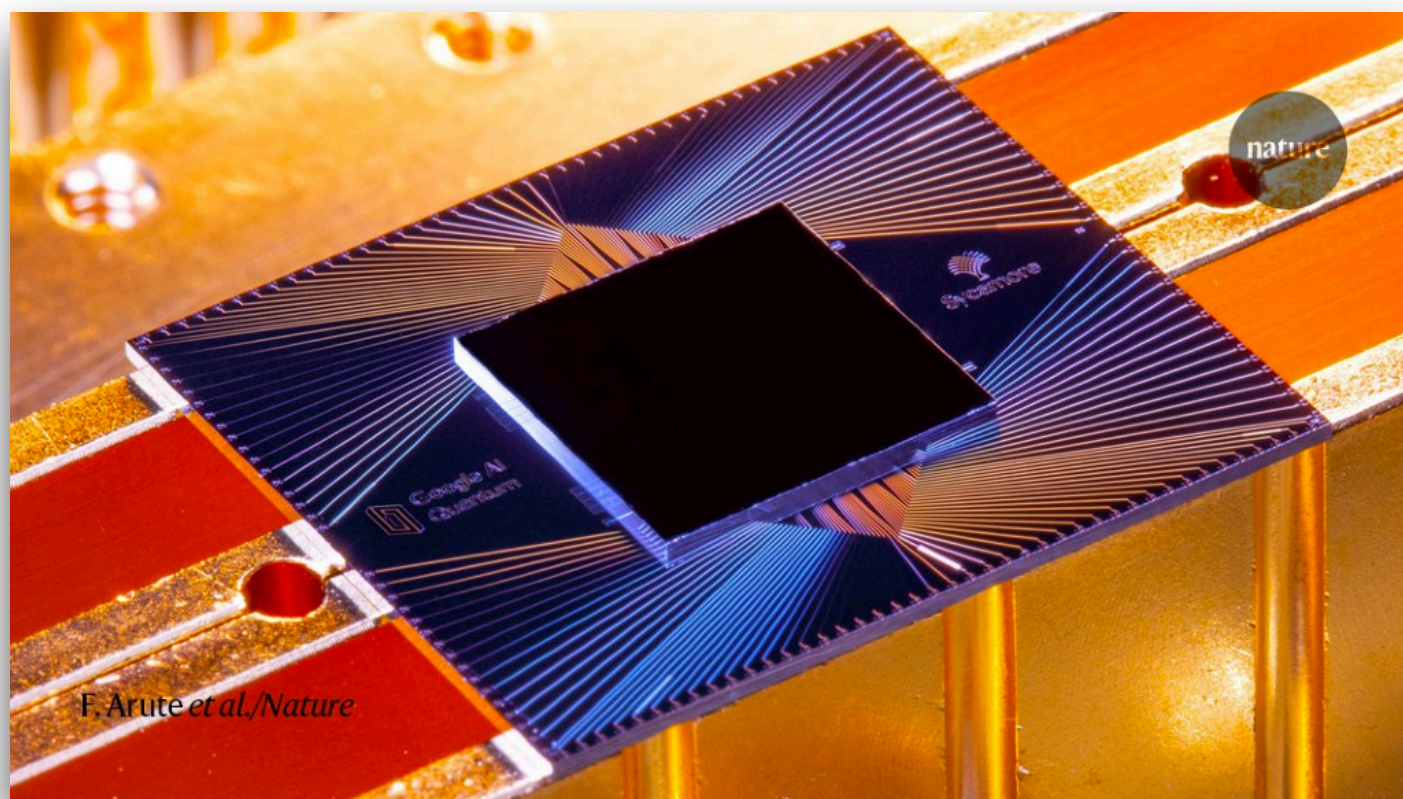

Example 2

ML tomography

Train/certify ML models, such as neural quantum states, using shadow overlap $\mathbb{E}[\omega]$

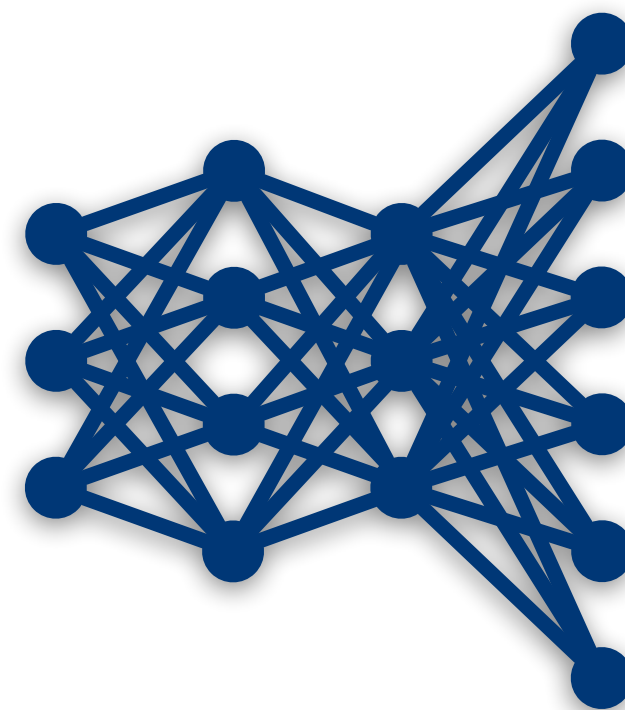

Example 3

Optimizing circuits

To prepare a target state $|\psi\rangle$, we can optimize the circuit to max shadow overlap $\mathbb{E}[\omega]$

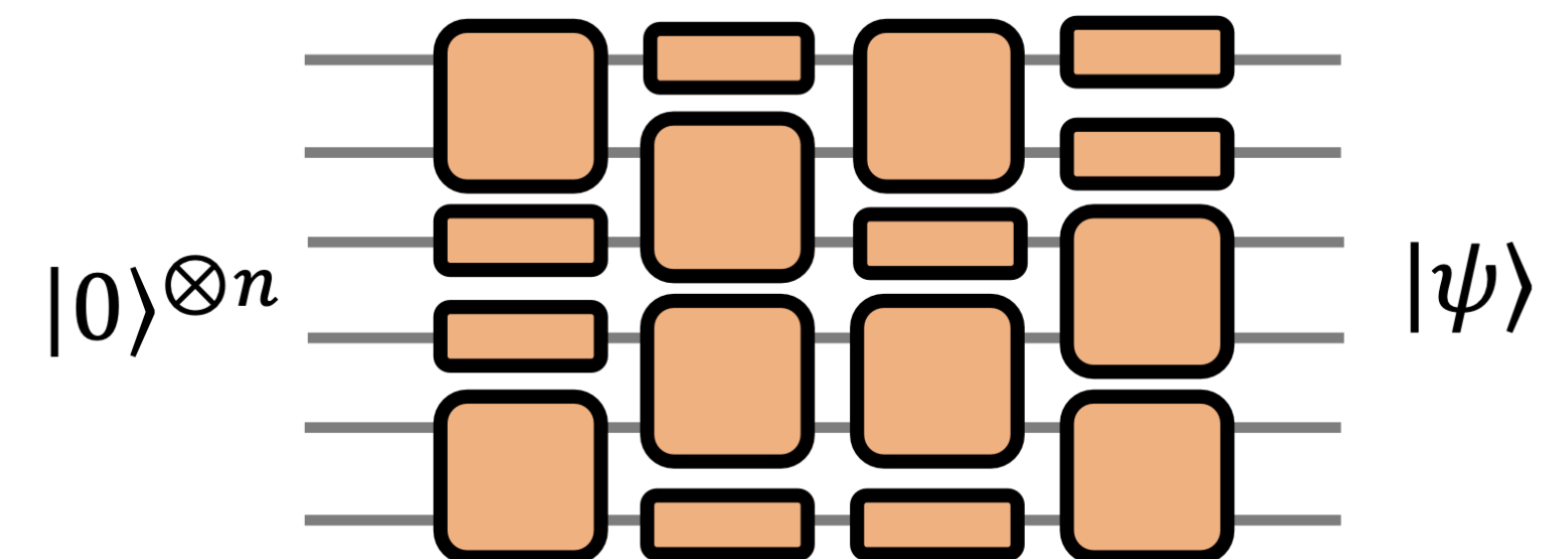

Optimizing state-preparation circuit

Constructing an n -qubit MPS
with H, CZ, T gates.

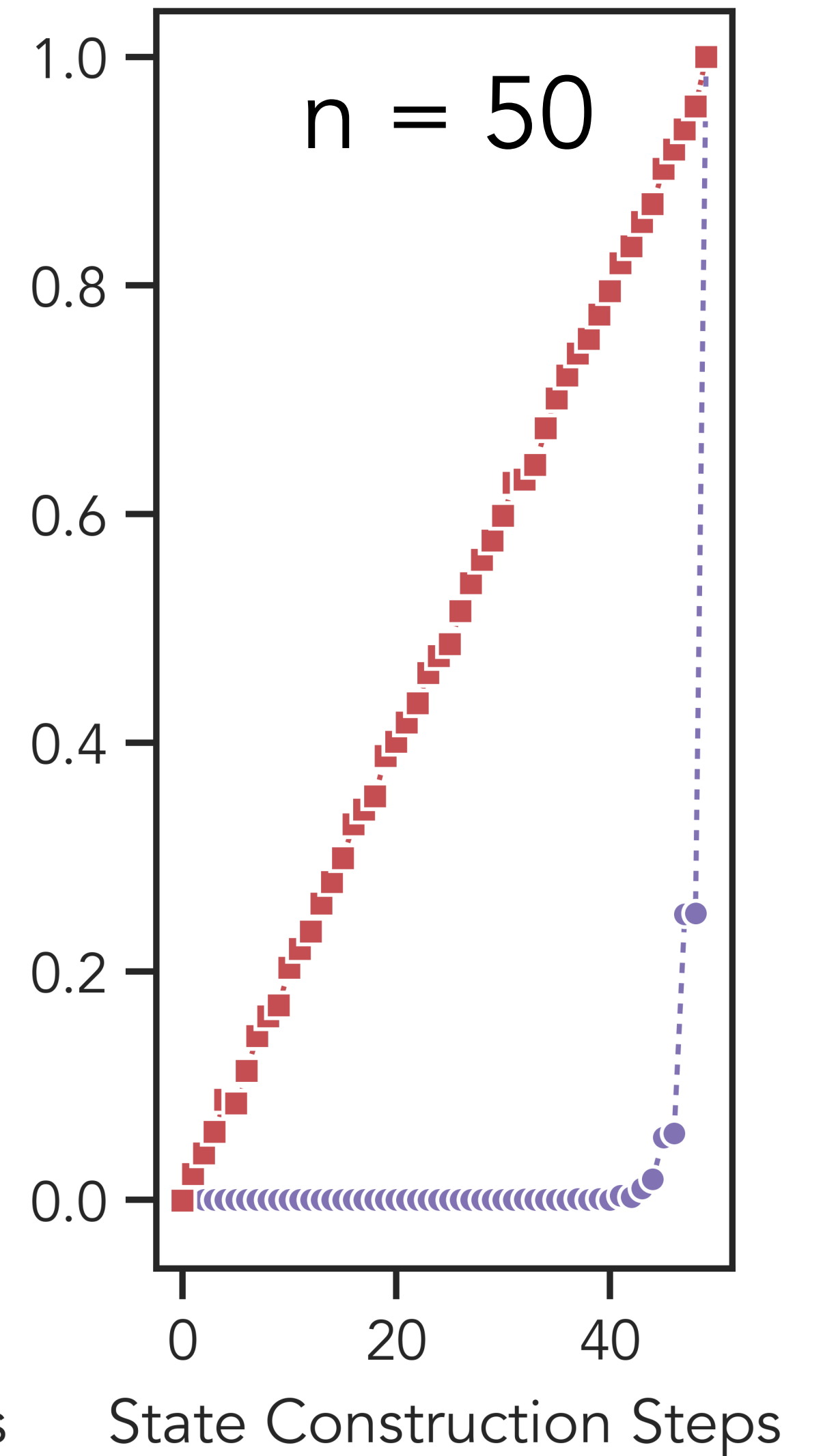
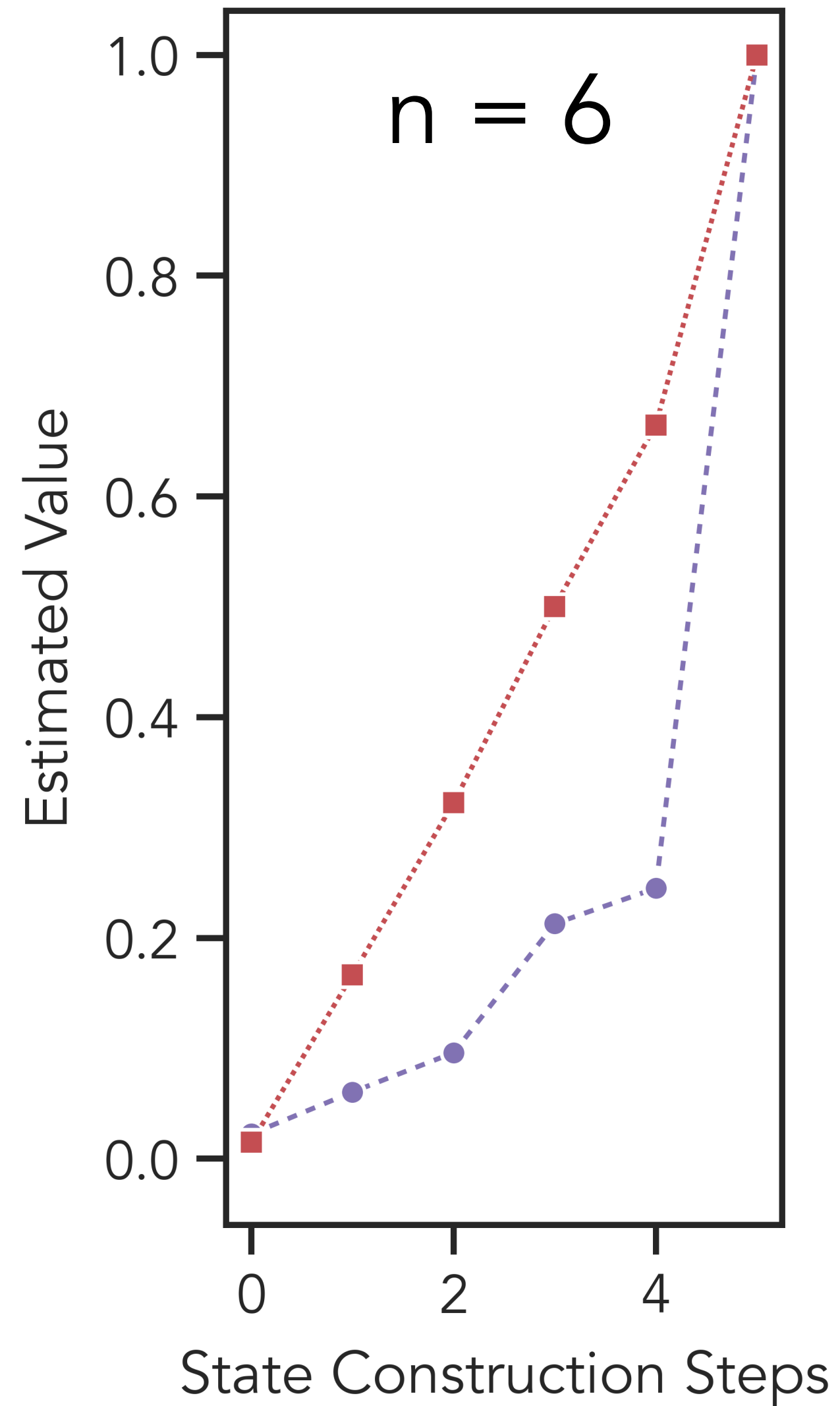

Optimizing state-preparation circuit

Training using Monte-Carlo optimization to prepare a 50-qubit MPS.

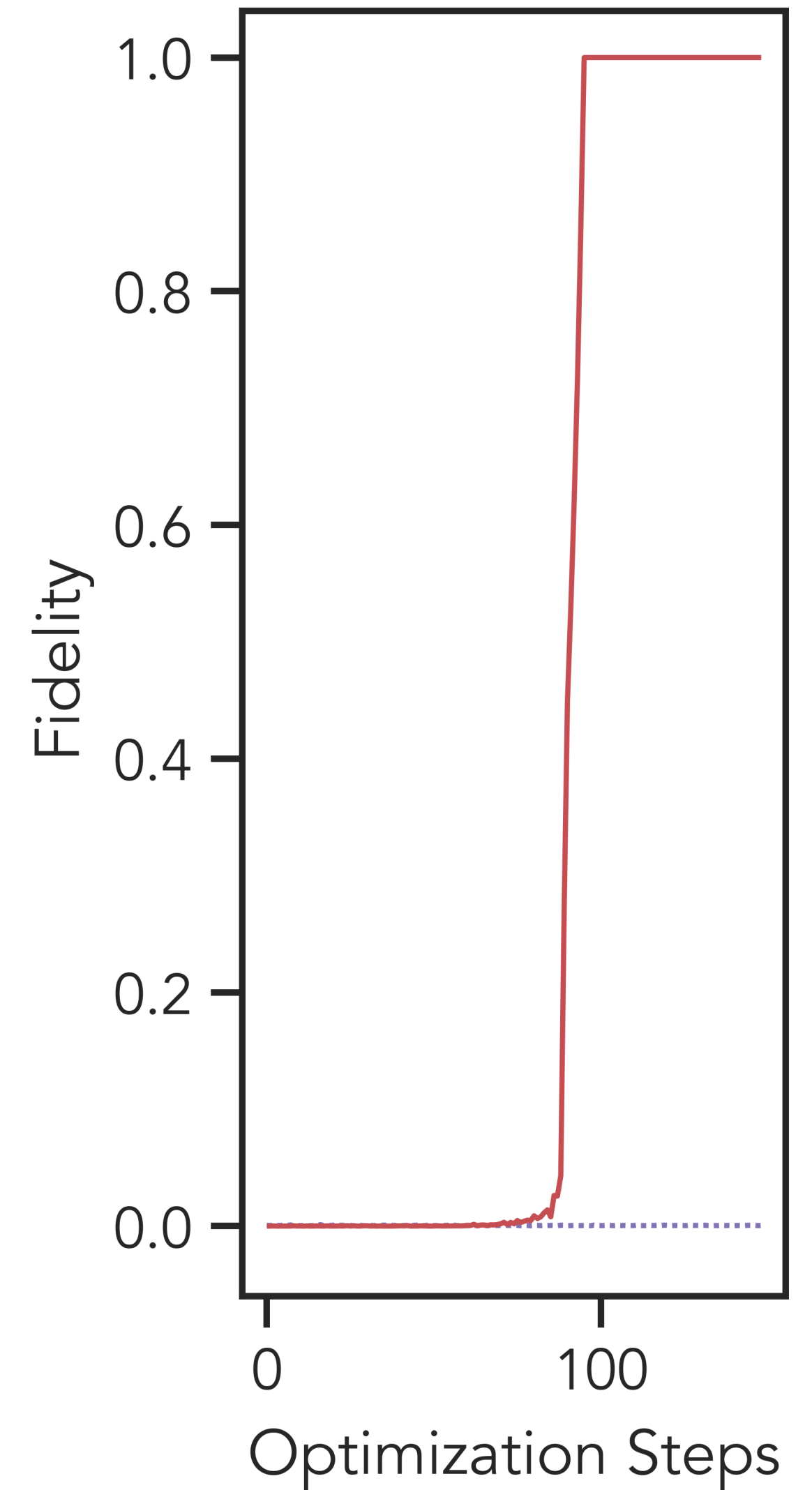
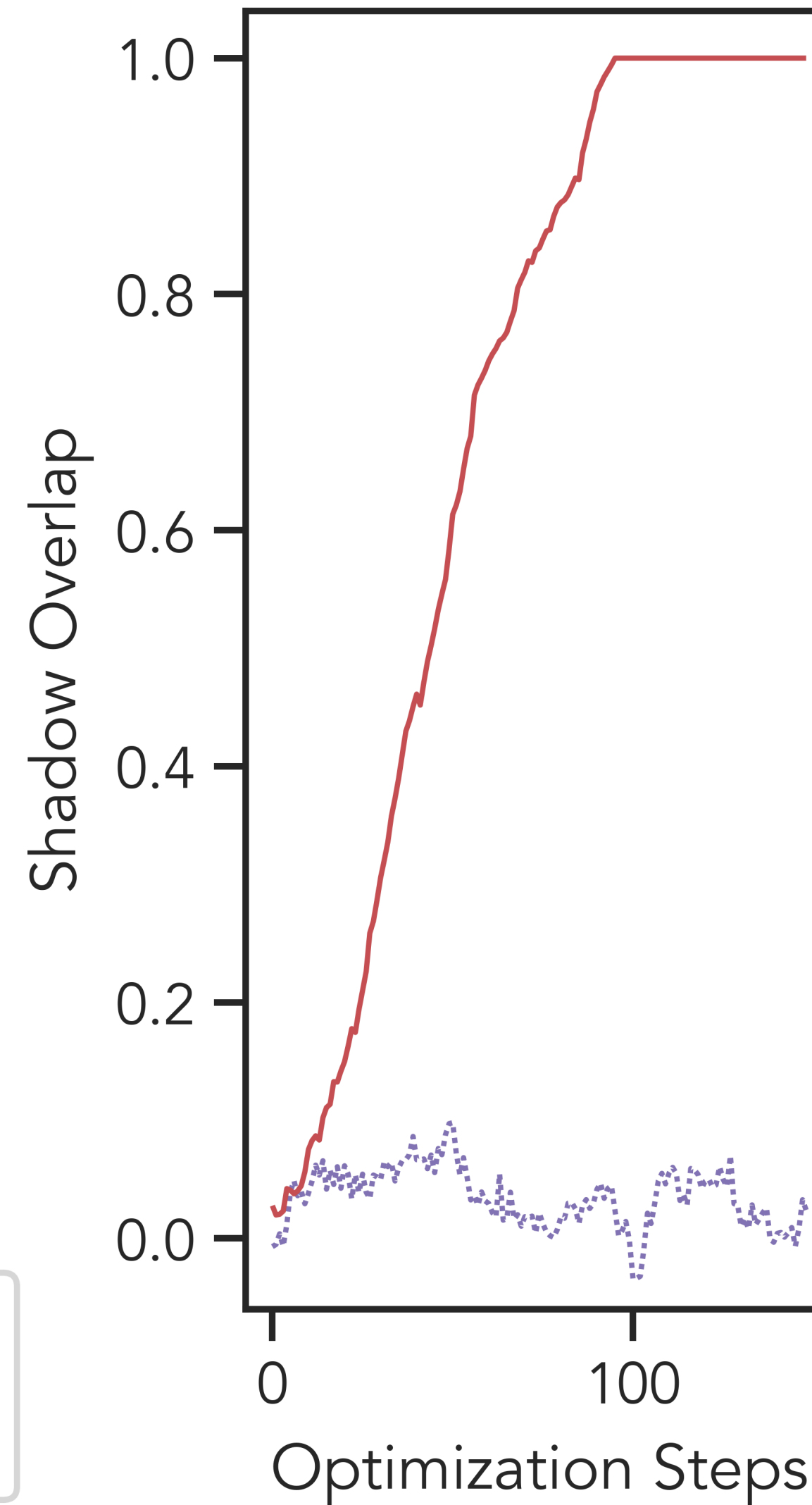
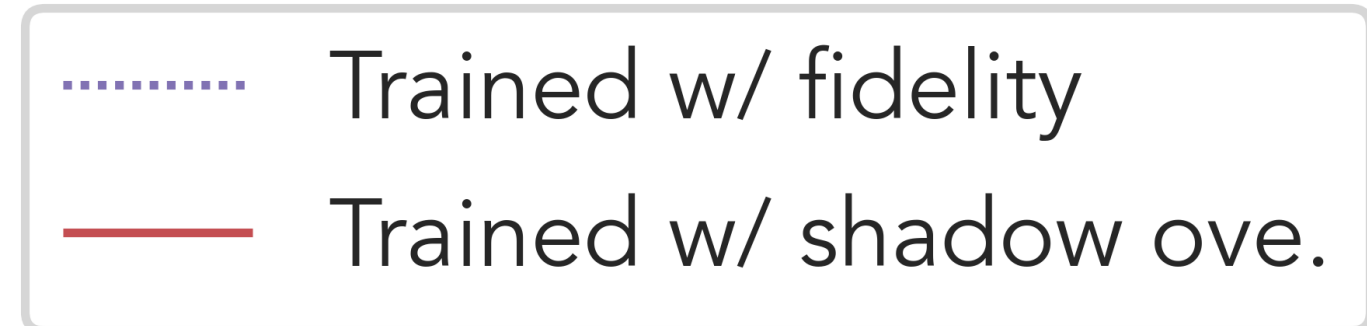

Applications

What can we use this new certification protocol for?

Example 1

Benchmarking

Shadow overlap $\mathbb{E}[\omega]$ certifies if the state has a high fidelity

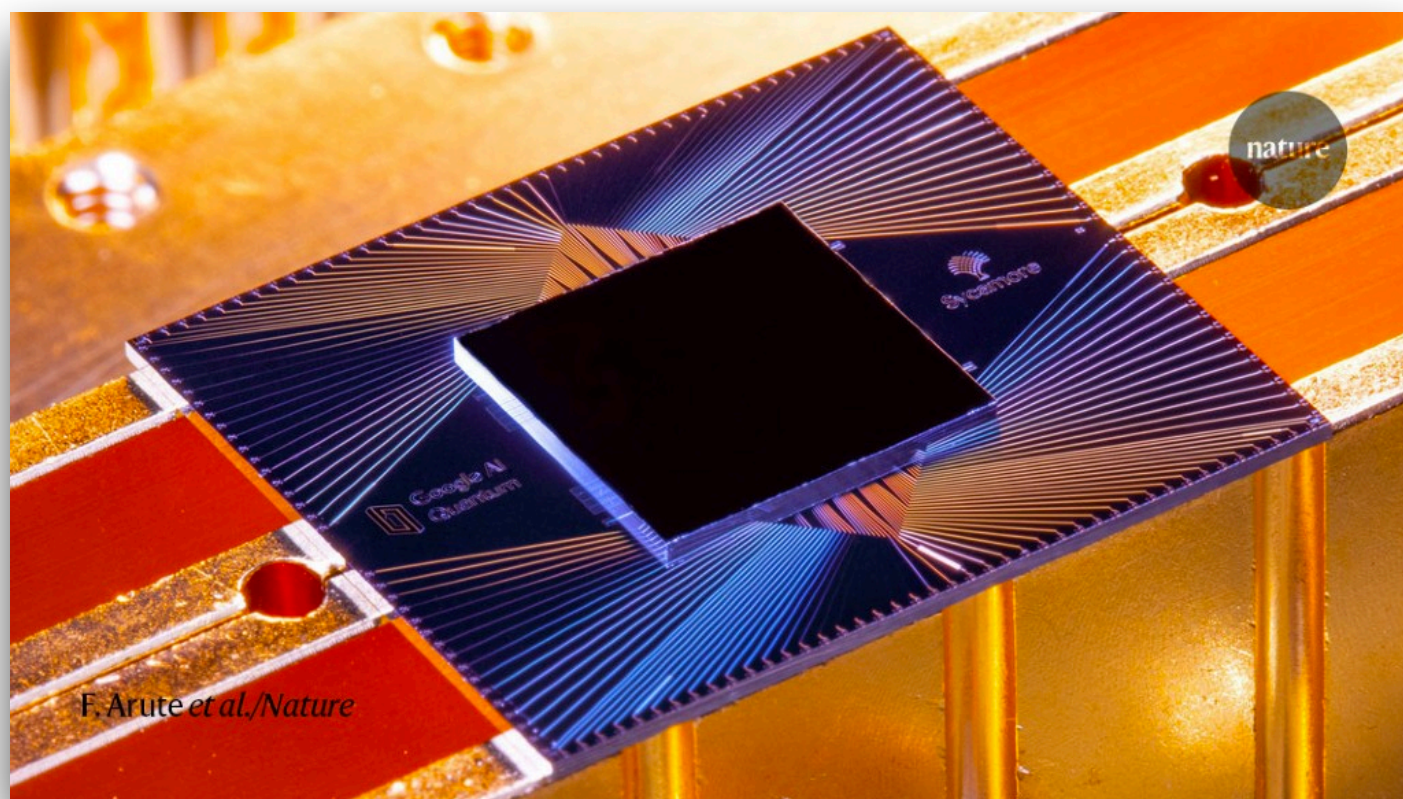

Example 2

ML tomography

Train/certify ML models, such as neural quantum states, using shadow overlap $\mathbb{E}[\omega]$

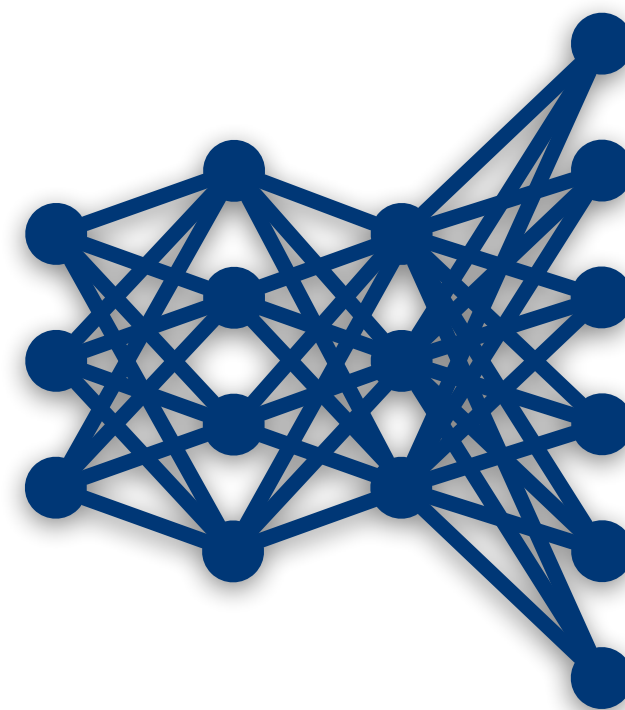

Example 3

Optimizing circuits

To prepare a target state $|\psi\rangle$, we can optimize the circuit to max shadow overlap $\mathbb{E}[\omega]$

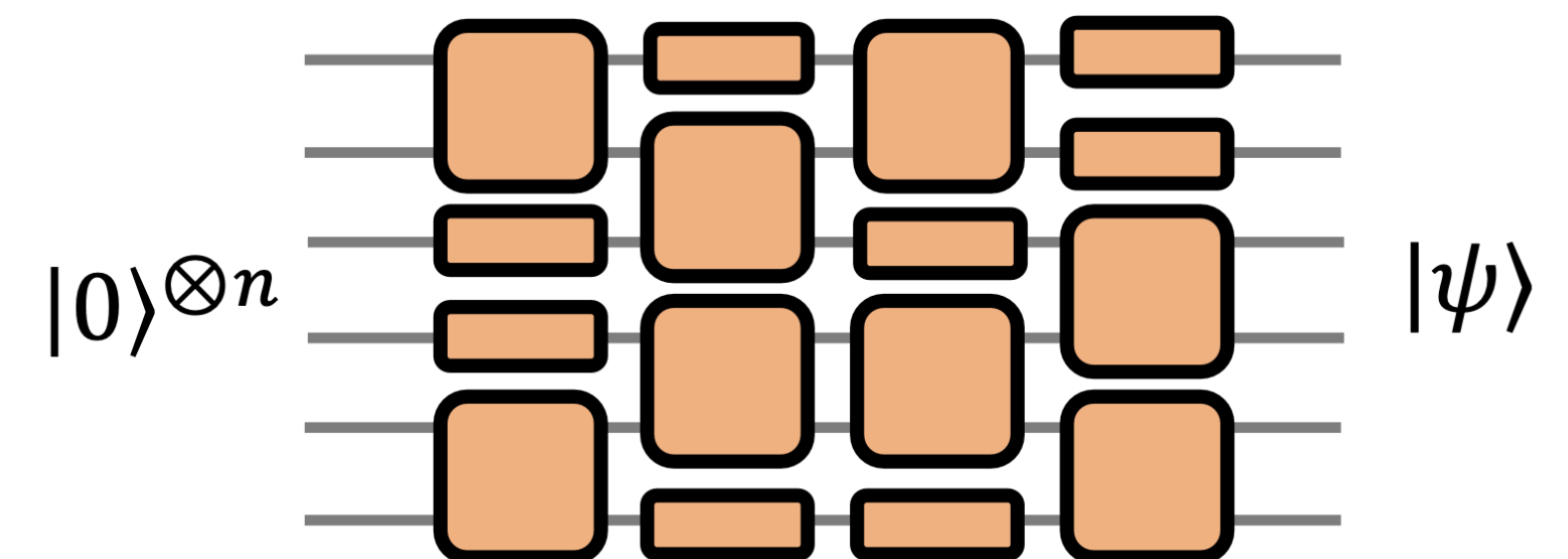

Conclusion

- We prove that **almost all quantum states** can be efficiently certified from **few single-qubit** measurements.
- Are there states not certifiable with **few single-qubit** measurements?

